

Models

Model	Temp	RH	PIR
TSUB00-100 TSUB30-100 TSUB60-100	•		
TSUB00-101 TSUB30-101 TSUB60-101	•	•	
TSUB00-104 TSUB30-104 TSUB60-104	•		•
TSUB00-105 TSUB30-105 TSUB60-105	•	•	•



TSUB00 Series



TSUB30 Series



TSUB60 Series

Description

The TSUB is a universal wall-mount controller with a built-in temperature sensor. The unit is designed for simple and accurate control of a fan coil unit or heating/cooling equipment. Its field configurable algorithms enable versatile implementation of required control sequences.

The controller is available with additional sensors, such as the PIR motion detection and humidity sensor, providing more functionality for the terminal device.

Equipped with an on-board humidity sensor, for accurate humidity control, this comprehensive unit also provides a dehumidification sequence compensated by auto activation of reheat output.

Features

- Fan control: 1, 2 or 3-speed (auto/on), or analog (ECM)
- Optional internal/external humidity sensor input for simple and accurate humidity control
- Dehumidification sequence compensated by auto activation of reheat output
- Real time clock (RTC) with 24-hour backup
- 7-day programmable schedule
- Precise temperature control with configurable PI (Proportional-Integral) function
- Selectable internal or external temperature sensor
- Low limit set protection (10°C / 50°F)
- Occupancy and night set back (NSB) mode
- Select direction on outputs
- Select controller's default display
- Multi-level lockable access menu and setpoint
- Selectable Fahrenheit or Celsius scale
- Option of pulse/floating/on-off output on binary outputs
- Internal/external occupancy input
- Compressor anti-cycling delay (configurable)
- ΔT control (on request)

Onboard Sensors

- Temperature sensor (°C/°F)
- Humidity sensor (%RH), select models
- PIR motion detection sensor, select models

Network Communication

- BACnet® MS/TP or Modbus communication port (selectable via configuration menu)
- Select MAC address via menu or via network
- Automatic baud rate detection

BACnet MS/TP®

- Automatic device instance configuration
- Copy & broadcast configuration via menu or via BACnet to other controllers
- BACnet scheduler (up to 6 events per day)
- Firmware upgradeable via BACnet
- Supports COV (change of value)

Modbus

- Modbus @ 9600, 19200, 38400 or 57600 bps
- RTU Slave, 8 bits (configurable parity and stop bits)
- Connects to any Modbus master

Technical Specifications

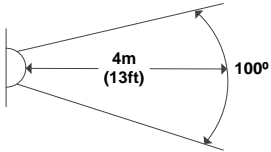
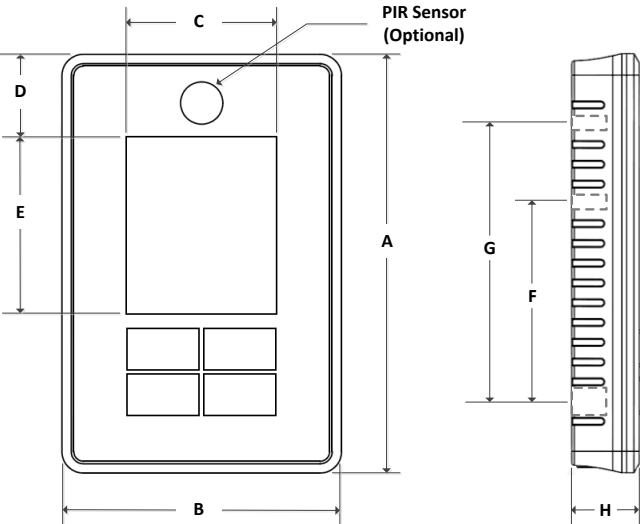
Description	TSUB Series
Temperature Sensor	
<i>Setpoint Range</i>	10°C to 40°C [50°F to 104°F]
<i>Control Accuracy</i>	Temperature: ±0.4°C [0.8°F]
<i>Display Resolution</i>	±0.1°C [0.2°F]
Humidity Sensor (select models)	
<i>Setpoint Range</i>	10% to 90% RH
<i>Control Accuracy</i>	±3.5% RH
<i>Display Resolution</i>	0.1%
PIR Motion Sensor (select models)	
<i>Operating Principle</i>	Passive Infrared (PIR)
<i>Detection Angle</i>	100°
<i>Detection Distance</i>	4m [13ft]
<i>Detection Area</i>	
Other	
Inputs	2 Universal Inputs (0-10Vdc, 10KΩ sensor, dry contact)
Outputs	5 Binary Outputs (OptoFET, 250mA max) 2 Analog Outputs (0-10Vdc, adjustable, 5mA max)
Power supply	22 to 26 Vac or Vdc 50/60Hz
Power consumption	1 VA max
Proportional band	0.5°C to 5°C [1°F to 9°F] adjustable (heat/cool/reheat independent)
Dead band	0.0°C to 5°C [0.0°F to 9°F] adjustable (heat/cool/reheat independent)
Electrical connection	0.8 mm ² [18 AWG] minimum
Operating temperature	0°C to 50°C [32°F to 122°F]
Storage temperature	-30°C to 50°C [-22°F to 122°F]
Relative Humidity	5 to 95% noncondensing
Degree of protection of housing	IP 30 (EN 60529)
Weight	135 g. [0.30 lb]
Dimensions: A = 4.88" 124mm B = 3.25" 83mm C = 1.75" 44mm D = 0.96" 24mm E = 2.07" 53mm F = 2.36" 60mm G = 3.28" 83mm H = 0.78" 20mm	



Wiring

We strongly recommend that all Neptronic products be wired to a separate grounded transformer and that transformer shall service only Neptronic products. This precaution will prevent interference with, and/or possible damage to incompatible equipment.

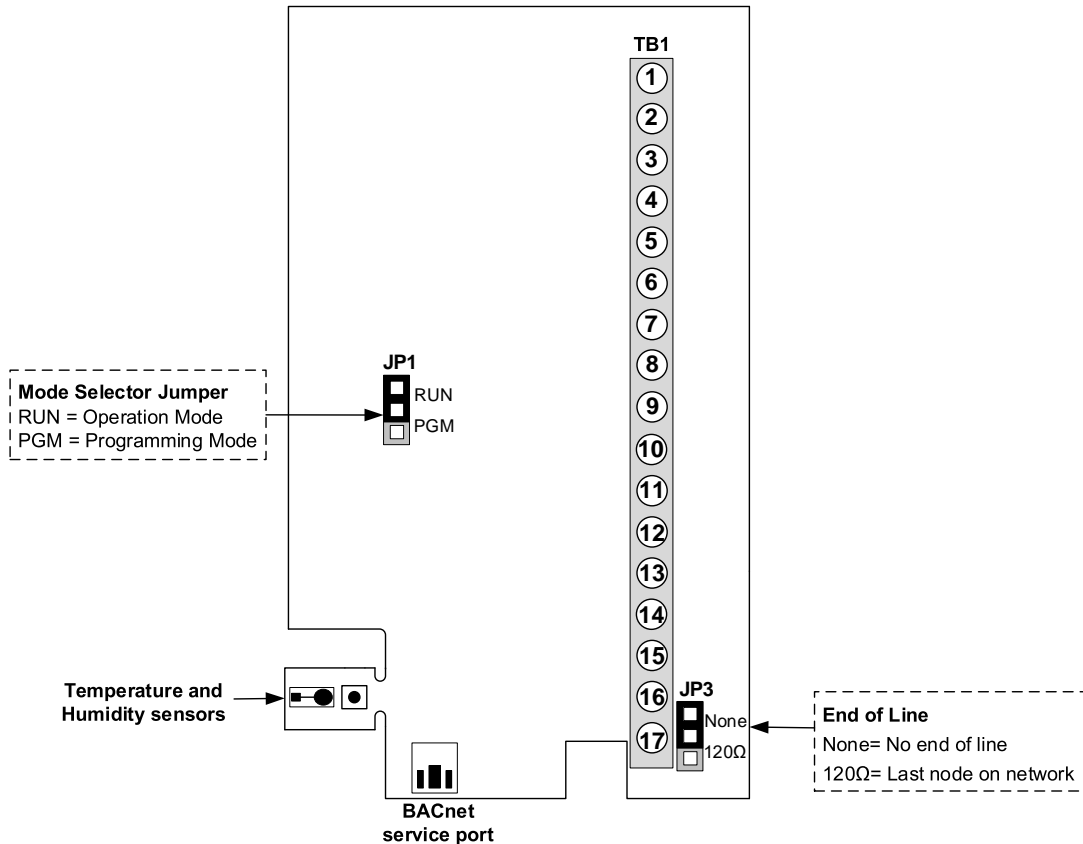

Terminal Description

Terminals	Analog Option			
	Fan analog	1-Speed Fan	2-Speed Fan	3-Speed Fan
1	COM	Common		
2	24V	24V (power supply)		
3	EXT SRC	External power supply		
4	N/A	N/A		
5	N/A	N/A		
6	BO3	select any ramp*		
7	BO4	select any ramp*		Fan (speed 3)
8	BO5	select any ramp*	Fan (speed 2)	Fan (speed 2)
9	BO6	select any ramp*	Fan (speed 1)	Fan (speed 1)
10	BO7	select any ramp*		
TB1	11	AO2	Fan Speed option • Modulating 0-10Vdc for ECM Motors • Steps of 3,6,9V for 3 Speed	select any ramp*
	12	AO3	select any ramp*	
	13	COM	Common	
	14	UI1	Universal Input selection: • 0-10 Vdc (External sensor, humidity, CO ₂) • 10K Ohm (External sensor, changeover) • Dry Contact**	
	15	UI2		
	16	A+	BACnet communication port (A+)	
	17	B-	BACnet communication port (B-)	

* = select from any of the following ramps:

- Cooling 1 w/ fan
- Cooling 2 w/ fan
- Heating 1 w/ fan
- Heating 2 w/ fan
- Heating 2 without fan
- Cool/Heat 1 w/ fan
- COR (changeover) w/ fan
- Humidify w/ fan
- CO₂ Alarm
- Off

** = select from any of the following:

- Off
- Override
- Flow Switch
- Local/Remote Selector Switch
- Overheat
- Dirty Filter
- Window & Door Contacts
- Occupancy & NSB Sensor
- Changeover Input



Wiring - 2 Pipe Terminal Description Details

Terminals	Analog				On/Off				
	Fan analog	1-Speed Fan	2-Speed Fan	3-Speed Fan	Fan analog	1-Speed Fan	2-Speed Fan	3-Speed Fan	
1	COM	Common				Common			
2	24V	24V (power supply)				24V (power supply)			
3	EXT SRC	External power supply				External power supply			
4	N/A	N/A				N/A			
5	N/A	N/A				N/A			
6	BO3	<i>select any ramp*</i>				On/Off Valve (CO _r)			
7	BO4	<i>select any ramp*</i>			Fan (speed 3)	<i>select any ramp*</i>			Fan (speed 3)
8	BO5	<i>select any ramp*</i>		Fan (speed 2)	Fan (speed 2)	<i>select any ramp*</i>		Fan (speed 2)	Fan (speed 2)
9	BO6	<i>select any ramp*</i>	Fan (speed1)	Fan (speed1)	Fan (speed1)	<i>select any ramp*</i>	Fan (speed1)	Fan (speed1)	Fan (speed1)
10	BO7	Heating Ramp 1 (Hr1)				Heating Ramp 1 (Hr1)			
11	AO2	Fan	Analog Local Reheat (HR1)			Fan	Analog Local Reheat (HR1)		
12	AO3	Changeover with fan (CO _r)				<i>select any ramp*</i>			
13	COM	Common				Common			
14	UI1	Changeover Input (SEnS)				Changeover Input (SEnS)			
15	UI2	Occupancy/Night Setback (OCC/nSb) External Temperature Sensor (t10.0) External Humidity Sensor (HU)				Occupancy/Night Setback (OCC/nSb) External Temperature Sensor (t10.0) External Humidity Sensor (HU)			
16	A+	BACnet communication port (A+)				BACnet communication port (A+)			
17	B-	BACnet communication port (B-)				BACnet communication port (B-)			

Terminals	Floating				
	Fan analog	1-Speed Fan	2-Speed Fan	3-Speed Fan	
1	COM	Common			
2	24V	24V (power supply)			
3	EXT SRC	External power supply			
4	N/A	N/A			
5	N/A	N/A			
6	BO3	Floating Valve (CO _r)			
7	BO4	<i>select any ramp*</i>			Fan (speed 3)
8	BO5	<i>select any ramp*</i>		Fan (speed 2)	Fan (speed 2)
9	BO6	<i>select any ramp*</i>	Fan (speed1)	Fan (speed1)	Fan (speed1)
10	BO7	Floating Valve (CO _r)			
11	AO2	Fan	Analog Local Reheat (HR1)		
12	AO3	<i>select any ramp*</i>			
13	COM	Common			
14	UI1	Changeover Input (SEnS)			
15	UI2	Occupancy/Night Setback (OCC/nSb) External Temperature Sensor (t10.0) External Humidity Sensor (HU)			
16	A+	BACnet communication port (A+)			
17	B-	BACnet communication port (B-)			

* = select from any of the following ramps:

- Cooling 1 w/ fan
- Cooling 2 w/ fan
- Heating 1 w/ fan
- Heating 2 w/ fan
- Heating 2 without fan
- Cool/Heat 1 w/ fan
- CO_r (changeover) w/ fan
- Humidify w/ fan
- CO₂ Alarm
- Off

† = Fan Speed Option:

- Modulating: 0-10Vdc for ECM Motors
- Steps of 3,6,9V for 3 Speed



Wiring - 4 Pipe Terminal Description Details

Terminals	Cool: Analog Heat: Analog			Cool: On/Off Heat: On/Off				
	1-Speed Fan	2-Speed Fan	3-Speed Fan	Fan Analog	1-Speed Fan	2-Speed Fan	3-Speed Fan	
1	COM	Common			Common			
2	24V	24V (power supply)			24V (power supply)			
3	EXT SRC	External power supply			External power supply			
4	N/A	N/A			N/A			
5	N/A	N/A			N/A			
6	BO3	<i>select any ramp*</i>			On/Off Heating Valve (Hr1)			
7	BO4	<i>select any ramp*</i>		Fan (speed 3)	<i>select any ramp*</i>			Fan (speed 3)
8	BO5	<i>select any ramp*</i>	Fan (speed 2)	Fan (speed 2)	<i>select any ramp*</i>		Fan (speed 2)	Fan (speed 2)
9	BO6	Fan (speed1)	Fan (speed1)	Fan (speed1)	<i>select any ramp*</i>	Fan (speed1)	Fan (speed1)	Fan (speed1)
10	BO7	<i>select any ramp*</i>			On/Off Cooling Valve (Cr1)			
11	AO2	Heating Valve (Hr1)			Fan Speed option †	Fan Speed option †	<i>select any ramp*</i>	
12	AO3	Cooling Valve (Cr1)			Heating Ramp 1 (Hr1)			
13	COM	Common			Common			
14	UI1	Occupancy/Night Setback (OCC/nSb)			Occupancy/Night Setback (OCC/nSb)			
15	UI2	External Temperature Sensor (t10.0) External Humidity Sensor (HU)			External Temperature Sensor (t10.0) External Humidity Sensor (HU)			
16	A+	BACnet communication port (A+)			BACnet communication port (A+)			
17	B-	BACnet communication port (B-)			BACnet communication port (B-)			

* = select from any of the following ramps:

- Cooling 1 w/ fan
- Cooling 2 w/ fan
- Heating 1 w/ fan
- Heating 2 w/ fan
- Heating 2 without fan
- Cool/Heat 1 w/ fan
- COR (changeover) w/ fan
- Humidify w/ fan
- CO₂ Alarm
- Off

† = Fan Speed Option:





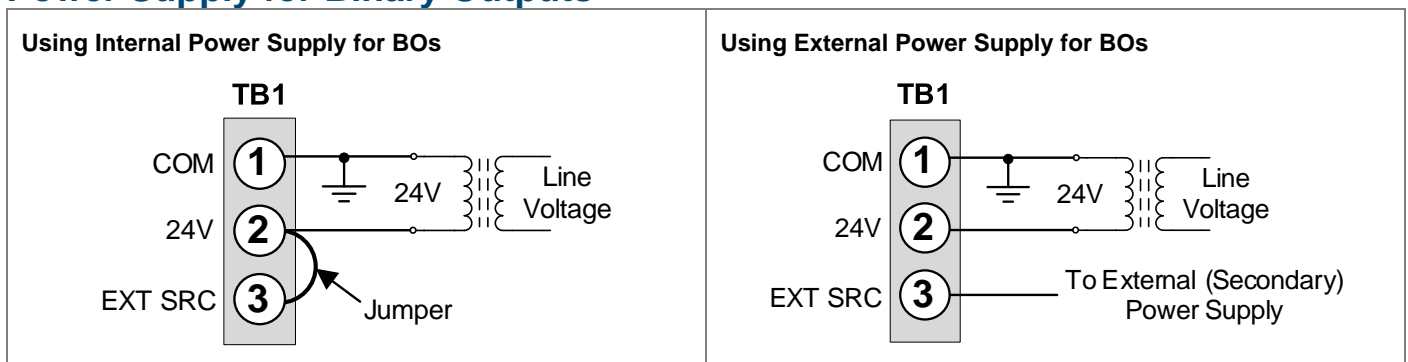

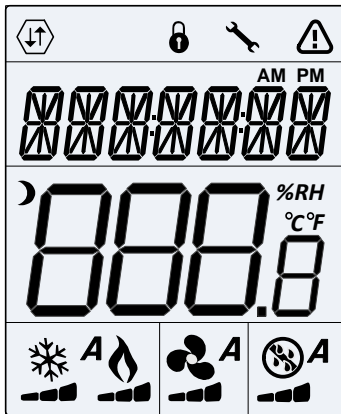

- Modulating: 0-10Vdc for ECM Motors
- Steps of 3,6,9V for 3 Speed

Power Supply for Binary Outputs



Interface



	Network Communication		User Lock		Programming Mode (Technician Setting)
	Alarm Status		Energy Saving Mode (NSB/OCC)	AM PM	Time
°C °F %RH	°C: Celsius Scale °F: Fahrenheit Scale %RH: Humidity	A	Automatic Mode		Cooling
	Heating		Fan		Humidify/De-humidify

Mounting Instructions

CAUTION: Remove power to avoid a risk of malfunction.

- Remove the captive screw that's holding the base and the front cover of the unit together.
- Lift the front cover of the unit to separate it from the base.
- Pull all wires through the holes in the base.
- Secure the base to the wall using wall anchors and screws (supplied). Make the appropriate connections.
- Mount the control module on the base and secure using the screw.

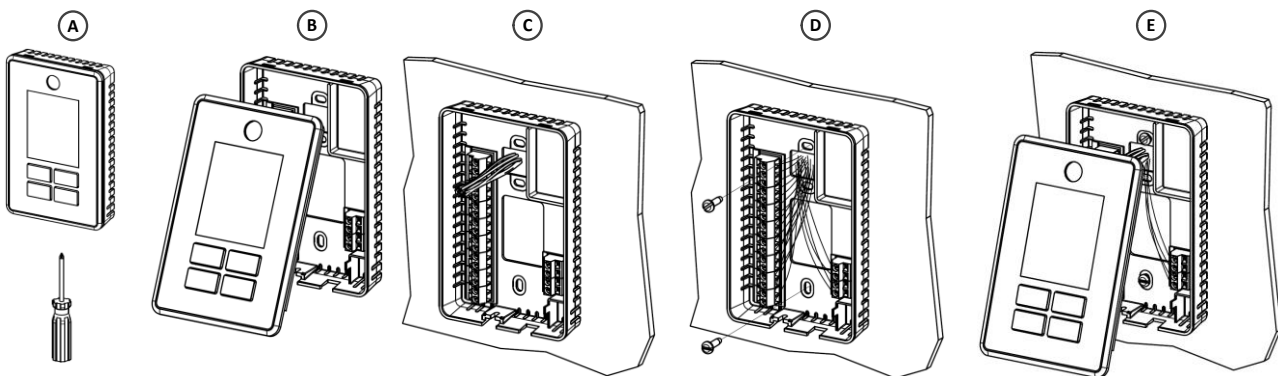

i Do not use the supplied screws to mount the unit to an electric box or an equivalent device. The supplied screws are only suitable for mounting the unit to the wall. Ensure to use the appropriate screws for any other application. Tighten by hand only and ensure not to overtighten the screws.

Programming Mode

i The Mode Selector jumper JP1 must be set to the PGM position (Programming Mode). Refer to the Wiring section on page 3. To exit, set the jumper back to the RUN position (Operation Mode). Advance to the next or return to the previous setting in order to save a changed value.

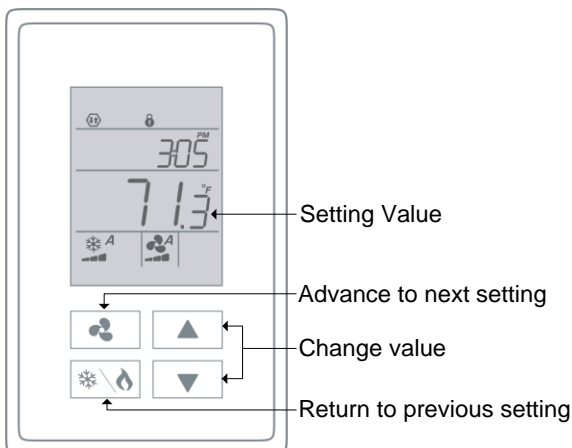



Symbols used in this Manual

Icon	Description	Icon	Description	Icon	Description	Icon	Description
	Temperature		Heating		Cooling		Humidity
	Fan		Analog Output 2		Analog Output 3		Time
	Binary Output 3		Binary Output 4		Binary Output 5		Binary Output 6
	Binary Output 7		Universal Input 1		Universal Input 2		Night Set Back
	Occupancy		Communication		Valve		Lock
	Carbon Dioxide						

Setpoint and User Control

1. "INTERN TEMP SENSOR OFFSET"

	Range:	0°C to 50°C	[32°F to 122°F]
	Offset:	Max. ± 5°C	[± 9°F]
	Increment:	0.1°C	[0.2°F]

Compare the displayed temperature reading with a known value from a thermometer or other temperature sensing device. To offset or calibrate the sensor, use the arrow buttons to set the desired temperature reading. This is useful for controllers installed in areas where the temperature read is slightly different than the room's actual temperature. For example, a controller placed right under the air diffuser.

2. "MINIMUM USER SETPNT"

	Default:	15°C	[59°F]
	Range:	10°C to 40°C	[50°F to 104°F]
	Increment:	0.5°C	[1.0°F]

In Operation mode, you cannot decrease the setpoint to less than the value set as the minimum user point. The minimum value is restricted by the maximum value set at Step 3, "Maximum User Setpnt". In other words, the value that is set as the minimum cannot be greater than the maximum value.

3. "MAXIMUM USER SETPNT"

	Default:	30°C	[86°F]
	Range:	10°C to 40°C	[50 to 104°F]
	Increment:	0.5°C	[1.0°F]

In Operation mode, you cannot increase the setpoint to more than the value set as the maximum user point. The maximum value is restricted by the minimum value set at Step 2, "Minimum User Setpnt". In other words, the value that is set as the maximum cannot be less than the minimum value.

4. "USER SETPNT LOCKED"

	Default:	No (Unlocked)
	Range:	No (Unlocked), yES (Locked)

If set to **No**, the user setpoint option is not locked and the user can adjust the desired temperature setpoint. If set to **yES**, the user setpoint option is locked and the user cannot set the desired temperature setpoint. A lock symbol appears to indicate that the setpoint is locked.

5. "USER SETPNT"

	Default:	22°C	[72°F]
	Range:	10°C to 40°C	[50°F to 104°F]
	Increment:	0.5°C	[1.0°F]

Set the desired temperature setpoint within the defined range. If the setpoint option was locked at Step 4, "User Setpnt locked", a lock symbol is displayed. The setpoint value is restricted by the minimum at Step 2, "Minimum User Setpnt" and maximum at Step 3, "Maximum User Setpnt" values. In other words, the setpoint should be within the minimum and maximum setpoint range.



6. "TEMP CONTROL MODE"



Default: Auto (Automatic)
Range: Auto (Automatic), HEAt (Heating Only), COOL (Cooling Only), On (Cooling or Heating), CLHt (Automatic only)

Select the control mode that you want to authorize to the user. To authorize all the available modes, select Auto (Automatic Mode). The cooling ❄️ and heating 🔥 symbols are also displayed. The selection made at this step determines the options available via the Control Mode (see page 34).

7. "ENABLE ON OFF CONTROL MODE"



Default: yES (Enable)
Range: yES (Enable), No (Disable)

If set to **yES**, the user can set the unit to "Off" via the Control Mode (see page 34). If set to **No**, the "Off" selection does not appear in the Control Mode.

8. "DISPLAY INFO"



Default: t - Hu %RH °C (temperature, humidity, and cooling heating demand)
Range: t - Hu %RH °C (temperature, humidity), StP %RH °C (temperature, humidity setpoint), OFF (no display), t - Hu %RH °C (temperature, humidity, and cooling heating demand), StP %RH °C (temperature, humidity setpoint, and cooling heating demand)

Select the desired information to appear on the display.

Keypad Lock Settings

9. "KEYPAD UPPER LEFT LOCKED"



Default: No (Disable)
Range: yES (Enable), No (Disable)

If set to **yES**, the 🔒 button is locked and cannot be used by the user. If set to **No**, the 🔒 button is unlocked and can be used by the user.

10. "KEYPAD LOWER LEFT LOCKED"



Default: No (Disable)
Range: yES (Enable), No (Disable)

If set to **yES**, the ❄️🔥 button is locked and cannot be used by the user. If set to **No**, the ❄️🔥 button is unlocked and can be used by the user.

11. "KEYPAD ARROWS LOCKED"



Default: No (Disable)
Range: yES (Enable), No (Disable)

If set to **yES**, the ▲ and ▼ buttons are locked and cannot be used by the user. If set to **No**, the ▲ and ▼ buttons are unlocked and can be used by the user.

Valve Settings

12. "VALVE SIZE"



Default: 1"
Range: 1/2", 3/4", 1"

Select the desired valve size in inches for the 6-way valve from the available options.

Analog Output 2 (AO2)

13. "AO2 RAMP"



Default: Hr1 (Heating Ramp 1)
Range: Cr1, Cr2, Hr1, Hr2 (heat with fan), Hr2 (heat without fan), CH1, HU, CO2, 6w, dto, VFdt, VFdP, FAN, OFF, COr

Select the desired signal from the available options.

- Cr1 (Cooling Ramp 1) or Cr2 (Cooling Ramp 2). The Cr1 and Cr2 ramps are used for cooling. If selected, the controller performs cooling based on the cooling proportional, integral, and dead band values.
- Hr1, Hr2 (heat with fan), or Hr2 (heat without fan). The Hr1 and Hr2 ramps are used for heating. If selected, the controller performs heating based on the heating proportional, integral, and dead band values.



- **CH1 (Cooling and Heating).** If selected, the controller performs cooling regularly. If another output is set to heat, it performs heating regularly.
- **HU (Humidify).** If selected, the controller modulates the output based on the humidify demand.
- **CO2 (Carbon dioxide).** If selected, the controller will activate or deactivate the output based on carbon dioxide levels.
- **6W (6-way Valve).** If selected, the controller will modulate the 6-way valve depending on the heating or cooling demand.
- **dto (Delta temperature control).** If selected, the controller will modulate the ΔT control based on the inlet and outlet temperature of the water inside the fan coil unit.
- **VFdt (VFD Temp Loop).** If selected, the controller will modulate the VFD fan based on the selected temperature input.
- **VFdP (VFD Pressure Loop).** If selected, the controller will modulate the static pressure based on the reading and the pressure setpoint.
- **FAN.** If selected, the controller modulates the output based on the Fan demand.
- **OFF.** If selected, the controller does not use the output.
- **CO_r (Changeover).** If selected, the controller will modulate heating and cooling, as appropriate.

If you select **OFF**, Steps 14 to 18 will not be available.

If you select **VFdt** or **VFdP**, Steps 26 to 32 will not be available.

If you select **CH1**, Step 25, "Minimum Cool 1 Heat 1 Percent" will be available.

If you select **FAN**, Step 26, "Fan Spd Signal" will not be available.

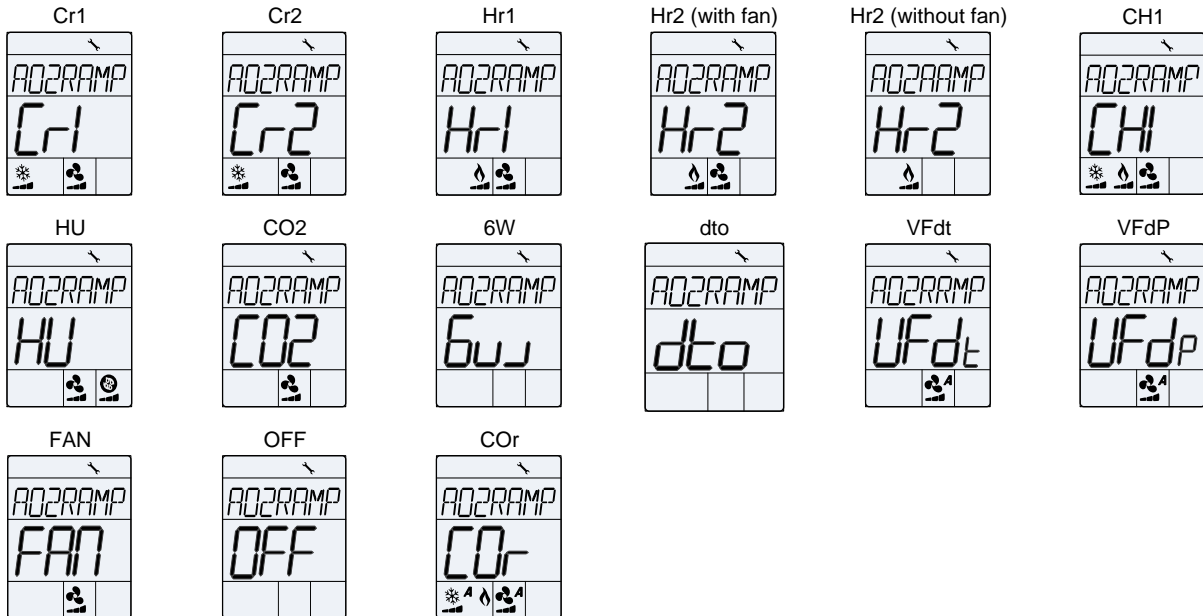

14. "AO2 MINIMUM VOLTAGE"

- **AO2** Default: 0.0 Volt
- Range: 0.0 to 10.0 Volts
- Increment: 0.1 Volt

This option does not appear if the signal ramp for AO2 is set to **OFF** (Step 13, "AO2 RAMP"). Select the desired minimum voltage ("zero" value) for the AO2 ramp. The minimum value is restricted by the maximum value at Step 15, "AO2 MAXIMUM VOLTAGE". In other words, the minimum value should be less than the maximum value.

15. "AO2 MAXIMUM VOLTAGE"

- **AO2** Default: 10.0 Volts
- Range: 0.0 to 10.0 Volts
- Increment: 0.1 Volt

This option does not appear if the signal ramp for AO2 is set to **OFF** (Step 13, "AO2 RAMP"). Select the desired maximum voltage ("span" value) for the AO2 ramp. The maximum value is restricted by the minimum value at Step 14, "AO2 MINIMUM VOLTAGE". In other words, the maximum value should not be less than the minimum value.

16. "AO2 OFF VOLTAGE"

- **AO2** Default: MIN (Minimum voltage)
- Range: MIN (Minimum voltage), OFF (0 Volt)

This option does not appear if the signal ramp for AO2 is set to **OFF** (Step 13, "AO2 Ramp"). Set the analog output voltage when the controller is turned off. When set to MIN, the output will remain at the minimum voltage level defined by (Step 14, "AO2 Minimum Voltage"). When set to OFF, the output will remain at 0V.

17. "AO2 DIRREV"

AO2 Default: dir (Direct)
Range: dir (Direct), rEV (Reverse)

This option does not appear if the signal ramp for AO2 is set to **OFF** (Step 13, "AO2RAMP"). Set the direction of the analog signal to either Direct (e.g. 0 to 10Vdc), or Reverse (e.g. 10 to 0Vdc).

18. "AO2 SIGNAL TYPE"

AO2 Default: ANLg (Analog Output)
Range: ANLg (Analog Output), OnOF (On/Off), PuLs (Pulsing)

This option does not appear if the signal ramp for AO2 is set to **OFF** (Step 13, "AO2RAMP"). Set the signal type for AO2 to either Analog Output, On/Off or Pulsing.

Analog Output 3 (AO3)

19. "AO3 RAMP"

AO3 Default: Hr1 (Heating Ramp 1)
Range: Cr1, Cr2, Hr1, Hr2 (heat with fan), Hr2 (heat without fan), CH1, HU, CO2, 6W, dto, OFF, COr

Select the desired signal from the available options. The AO2 input signal has priority over AO3.

- *Cr1 (Cooling Ramp 1) or Cr2 (Cooling Ramp 2). The Cr1 and Cr2 ramps are used for cooling. If selected, the controller performs cooling based on the cooling proportional, integral, and dead band values.*
- *Hr1, Hr2 (heat with fan), or Hr2 (heat without fan). The Hr1 and Hr2 ramps are used for heating. If selected, the controller performs heating based on the heating proportional, integral, and dead band values.*
- *CH1 (Cooling and Heating). If selected, the controller performs cooling regularly. If another output is set to heat, it performs heating regularly.*
- *HU (Humidify). If selected, the controller modulates the output based on the humidify demand.*
- *CO2 (Carbon dioxide). If selected, the controller will activate or deactivate the output based on carbon dioxide levels.*
- *6W (6-way Valve). If selected, the controller will modulate the 6-way valve depending on the heating or cooling demand.*
- *dto (Delta temperature control). If selected, the controller will modulate the ΔT control based on the inlet and outlet temperature of the water inside the fan coil unit.*
- *OFF. If selected, the controller does not use the output.*
- *COr (Changeover). If selected, the controller will modulate heating and cooling, as appropriate.*

If you select **OFF**, Steps 20 to 24 will not be available.

If you select **CH1**, Step 25, "Minimum Cool 1 Heat 1 Percent" will be available.

If you select **FAN**, Step 26, "Fan Spd Signal" will not be available.

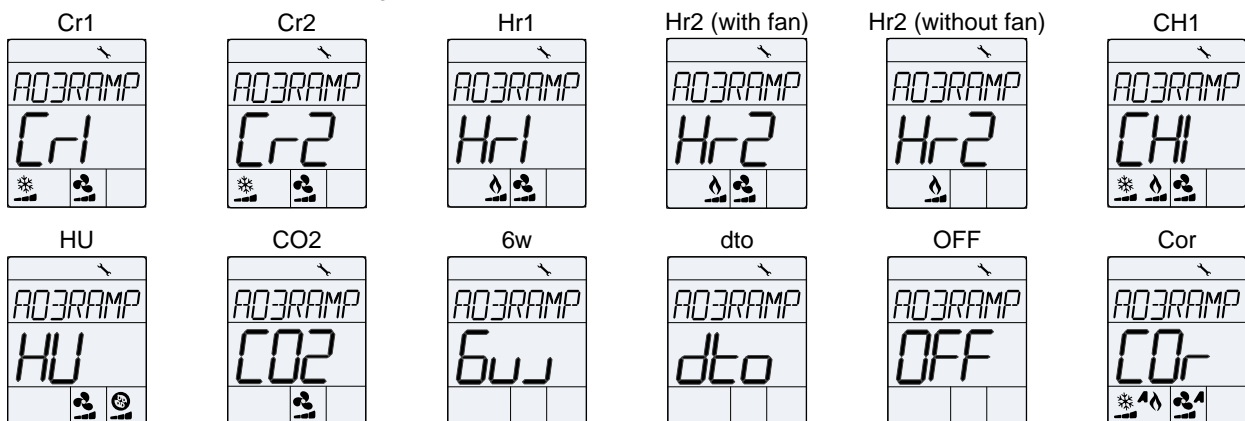

20. "AO3 MINIMUM VOLTAGE"

AO3 Default: 0.0 Volt
Range: 0.0 to 10.0 Volts
Increment: 0.1 Volt

This option does not appear if the signal ramp for AO3 is set to **OFF** (Step 19, "AO3RAMP"). Select the desired minimum voltage ("zero" value) for the AO3 ramp. The minimum value is restricted by the maximum value at Step 21, "AO3 MAXIMUM VOLTAGE". In other words, the minimum value should be less than the maximum value.

21. "AO3 MAXIMUM VOLTAGE"

	Default:	10.0 Volts
	Range:	0.0 to 10.0 Volts
	Increment:	0.1 Volt

This option does not appear if the signal ramp for AO3 is set to **OFF** (Step 19, "AO3 RAMP"). Select the desired maximum voltage ("span" value) for the AO3 ramp. The maximum value is restricted by the minimum value at Step 20, "AO3 Minimum Voltage". In other words, the maximum value should not be less than the minimum value.

22. "AO3 OFF VOLTAGE"

	Default:	MIN (Minimum voltage)
	Range:	MIN (Minimum voltage), OFF (0 Volt)

This option does not appear if the signal ramp for AO3 is set to **OFF** (Step 19, "AO3 Ramp"). Set the analog output voltage when the controller is turned off. When set to MIN, the output will remain at the minimum voltage level defined by Step 20, "AO3 Minimum Voltage". When set to OFF, the output will remain at 0V.

23. "AO3 DIRREV"

	Default:	dir (Direct)
	Range:	dir (Direct), rEV (Reverse)

This option does not appear if the signal ramp for AO3 is set to **OFF** (Step 19, "AO3 RAMP"). Set the direction of the analog signal to either Direct (e.g. 0 to 10Vdc), or Reverse (e.g. 10 to 0Vdc).

24. "AO3 SIGNAL TYPE"

	Default:	ANLg (Analog Output)
	Range:	ANLg (Analog Output), OnOF (On/Off), PuLs (Pulsing)

This option does not appear if the signal ramp for AO3 is set to **OFF** (Step 19, "AO3 RAMP"). Set the signal type for AO3 to either Analog Output, On/Off or Pulsing.

25. "MINIMUM COOL | HEAT | PERCENT"

	Default:	0 %
	Range:	0 to 100%
	Increment:	5 %

This option appears if you have selected **CH1** at Step 13, "AO2 Ramp" or at Step 19, "AO3 RAMP". Set the percentage at which the controller sets the CH1 output during heating, provided another output has also been set to heating.

Fan Settings

26. "FAN SPD SIGNAL"

	Default:	3
	Range:	1, 2, 3

This option does not appear if you have selected **FAN** at Step 13, "AO2 RAMP". Select the desired number of fan speed contacts. The fan  symbol is also displayed.

27. "FAN SPEED OPTION"

	Default:	Std (Standard)
	Range:	AdV (Advanced), Std (Standard)

Select between the Standard (Neptronic) and Advanced (OE1) fan speed specifications. The fan  symbol is also displayed.

28. "ENABLE FAN CONTRL MODE"

	Default:	No (Disable)
	Range:	yES (Enable), No (Disable)

This option appears only if you have selected **Adv** at Step 27, "FAN SPEED OPTION". Select to enable or disable the fan control mode option. If you select **No**, the Fan Speed Selection Mode option is not available in Control Mode. The fan  symbol is also displayed.

29. "HIDE FAN DISPLAY INFO"

	Default:	No (Disable)
	Range:	yES (Enable), No (Disable)

Select to enable or disable the fan display information. If you select **Yes**, the Fan demand (fan icon) does not appear on the display and the Fan Speed Selection Mode is disabled. The fan  symbol is also displayed.

30. "FAN AUTO MODE"



Default: yES (Enable)
Range: yES (Enable), No (Disable)

If set to **yES**, the user can set the fan speed to "Automatic" via the Fan Speed Selection Mode (see page 35). If set to **No**, the "Automatic" speed does not appear in the Fan Speed Selection Mode. The fan  symbol is also displayed.

If you select **yES**, Step 31 "Fan Auto Timeout Seconds" will be available.

If you select **No**, Step 31 "Fan Auto Timeout Seconds" will not be available.

31. "FAN AUTO TIMEOUT SECONDS"



Default: 120 seconds
Range: 0 to 255 seconds
Increment: 1 second

This option appears only if you have selected **yES** at Step 30, "FAN AUTO MODE". Select the desired value for the automatic shutoff delay when there is no demand. The fan  symbol is also displayed.

32. "DAMPING FACTOR TIME IN SECONDS"



Default: 0 second
Range: 0 to 255 seconds
Increment: 1 second

Select the desired damping factor value for the fan. The fan  symbol is also displayed.

Binary Output 3 (BO3)

33. "BO3 RAMP"



Default: Hr1 (Heating Ramp 1)
Range: Cr1, Cr2, Hr1, Hr2 (heat with fan), Hr2 (heat without fan), CH1, HU, CO2, OFF, COr

Select the desired ramp from the available options.

- *Cr1 (Cooling Ramp 1) or Cr2 (Cooling Ramp 2). The Cr1 and Cr2 ramps are used for cooling. If selected, the controller performs cooling based on the cooling proportional, integral, and dead band values.*
- *Hr1, Hr2 (heat with fan), or Hr2 (heat without fan). The Hr1 and Hr2 ramps are used for heating. If selected, the controller performs heating based on the heating proportional, integral, and dead band values.*
- *CH1 (Cooling and Heating). If selected, the controller performs cooling regularly. If another output is set to heat, it performs heating regularly.*
- *HU (Humidify). If selected, the controller modulates the output based on the humidify demand.*
- *CO2 (Carbon dioxide). If selected, the controller will activate or deactivate the output based on carbon dioxide levels.*
- *OFF. If selected, the controller does not use the output.*
- *COr (Changeover). If selected, the controller will modulate heating and cooling, as appropriate.*

If you select **OFF**, Steps 34 to 39 will not be available.

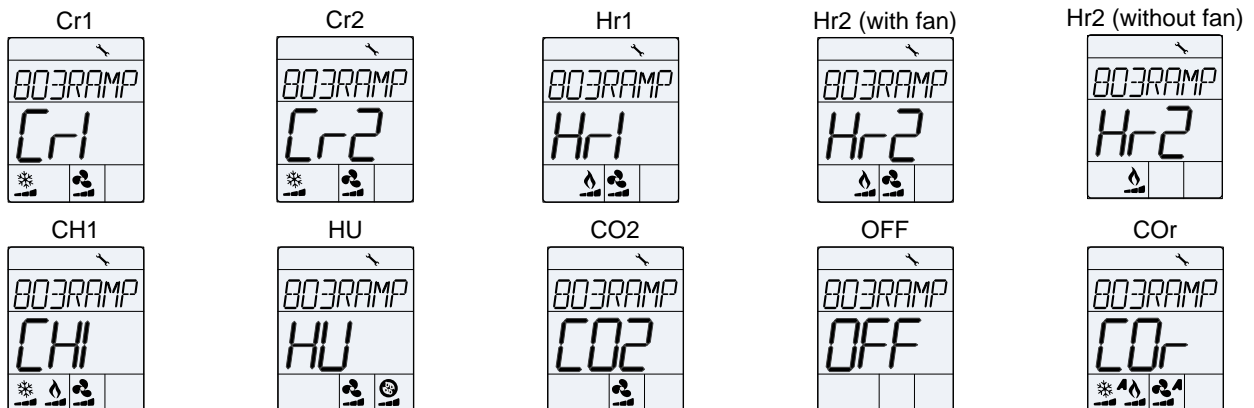

34. "BO3 SIGNAL TYPE"



Default: OnOF (On/Off)
Range: tPm (Pulsing), OnOF (On/Off), FLOt (Floating)

This option does not appear if the signal ramp for BO3 is set to **OFF** (Step 33, "BO3 Ramp"). Select the signal type for BO3 to either Pulsing, On/Off or Floating.

35. "BO3 FLOAT TIMER SECONDS"

	Default:	100 seconds
	Range:	15 to 250 seconds
	Increment:	5 seconds

This option only appears if the signal type for BO3 is set to **FLoT** (Step 34, "BO3 Signal Type"). Set the time required for the valve actuator to complete a stroke.

36. "BO3 CLOSE PERCENT"

	Default:	50% of the demand
	Range:	15 to 80%
	Increment:	1%

This option does not appear if the signal ramp for BO3 is set to **OFF** (Step 33, "BO3 Ramp") and if the signal type for BO3 is set to either **tPm** or **FLoT** (Step 34, "BO3 Signal Type"). Select the percentage at which you want BO3 to close (at % of demand of the ramp selected at Step 33, "BO3 Ramp").

37. "BO3 OPEN PERCENT"

	Default:	25% of the demand
	Range:	0 to (BO3 Close)-4%
	Increment:	1%

This option does not appear if the signal ramp for BO3 is set to **OFF** (Step 33, "BO3 Ramp") and if the signal type for BO3 is set to either **tPm** or **FLoT** (Step 34, "BO3 Signal Type"). Select the percentage at which you want BO3 to open (at % of demand of the ramp selected at Step 33, "BO3 Ramp").

38. "BO3 DIRREV"

	Default:	dir (Direct)
	Range:	dir (Direct), rEV (Reverse)

This option does not appear if the signal ramp for BO3 is set to **OFF** (Step 33, "BO3 Ramp") and if the signal type for BO3 is set to either **tPm** or **FLoT** (Step 34, "BO3 Signal Type"). Set the direction of the binary signal to either Direct or Reverse.

39. "BO3 CONTACT DELAY MINUTES"

	Default:	0 minute
	Range:	0 to 15 minutes
	Increment:	1 minute

This option does not appear if the signal ramp for BO3 is set to **OFF** (Step 33, "BO3 Ramp") and if the signal type for BO3 is set to either **tPm** or **FLoT** (Step 34, "BO3 Signal Type"). Select the closing delay for BO3 output.

Binary Output 4 (BO4)

The Binary Output 4 settings appear only if you have selected either fan speed 1 or 2 at Step 26, "Fan Spd Signal" or VFdP, VFdt or FAN at Step 13, "AO2 Ramp".

40. "BO4 RAMP"

	Default:	OFF
	Range:	Cr1, Cr2, Hr1, Hr2 (heat with fan), Hr2 (heat without fan), CH1, HU, CO2, OFF, COr

Select the desired ramp from the available options. Same as BO3 options.

If you select **OFF**, Steps 41 to 45 will not be available.

41. "BO4 SIGNAL TYPE"

	Default:	OnOF (On/Off)
	Range:	tPm (Pulsing), OnOF (On/Off)

This option does not appear if the signal ramp for BO4 is set to **OFF** (Step 40, "BO4 Ramp"). Select the signal type BO4 to either Pulsing or On/Off.

42. "BO4 CLOSE PERCENT"

	Default:	20% of the demand
	Range:	15 to 80%
	Increment:	1%

This option does not appear if the signal ramp for BO4 is set to **OFF** (Step 40, "BO4 Ramp") and if the signal type for BO4 is set to **tPm** (Step 41, "BO4 Signal Type"). Select the percentage at which you want BO4 to close (at % of demand of the ramp selected at Step 40, "BO4 Ramp").

43. "BO4 OPEN PERCENT"

	Default:	0% of the demand
	Range:	0 to (BO4 Close)-4%
	Increment:	1%

This option does not appear if the signal ramp for BO4 is set to **OFF** (Step 40, "BO4 Ramp") and if the signal type for BO4 is set to **tPm** (Step 41, "BO4 Signal Type"). Select the percentage at which you want BO4 to open (at % of demand of the ramp selected at Step 40, "BO4 Ramp").

44. "BO4 DIRREV"

	Default:	dir (Direct)
	Range:	dir (Direct), rEV (Reverse)

This option does not appear if the signal ramp for BO4 is set to **OFF** (Step 40, "BO4 Ramp") and if the signal type for BO4 is set to **tPm** (Step 41, "BO4 Signal Type"). Set the direction of the binary signal to either Direct or Reverse.

45. "BO4 CONTACT DELAY MINUTES"

	Default:	0 minute
	Range:	0 to 15 minutes
	Increment:	1 minute

This option does not appear if the signal ramp for BO4 is set to **OFF** (Step 40, "BO4 Ramp") and if the signal type for BO4 is set to **tPm** (Step 41, "BO4 Signal Type"). Select the closing delay for BO4 output.

Binary Output 5 (BO5)

The Binary Output 5 settings appear only if you have selected either fan speed 1 at Step 26, "Fan Spd Signal" or VFdP, VFdt or FAN at Step 13, "AO2 Ramp".

46. "BO5 RAMP"

	Default:	OFF
	Range:	Cr1, Cr2, Hr1, Hr2 (heat with fan), Hr2 (heat without fan), CH1, HU, CO2, OFF, COr

Select the desired ramp from the available options. Same as BO3 options.

If you select **OFF**, Steps 47 to 51 will not be available.

47. "BO5 SIGNAL TYPE"

	Default:	OnOF (On/Off)
	Range:	tPm (Pulsing), OnOF (On/Off)

This option does not appear if the signal ramp for BO5 is set to **OFF** (Step 46, "BO5 Ramp"). Select the signal type for BO5 to either Pulsing or On/Off.

48. "BO5 CLOSE PERCENT"

	Default:	20% of the demand
	Range:	15 to 80%
	Increment:	1%

This option does not appear if the signal ramp for BO5 is set to **OFF** (Step 46, "BO5 Ramp") and if the signal type for BO5 is set to **tPm** (Step 47, "BO5 Signal Type"). Select the percentage at which you want BO5 to close (at % of demand of the ramp selected at Step 46, "BO5 Ramp").

49. "BO5 OPEN PERCENT"

	Default:	0% of the demand
	Range:	0 to (BO5 Close)-4%
	Increment:	1%

This option does not appear if the signal ramp for BO5 is set to **OFF** (Step 46, "BO5 Ramp") and if the signal type for BO5 is set to **tPm** (Step 47, "BO5 Signal Type"). Select the percentage at which you want BO5 to open (at % of demand of the ramp selected at Step 46, "BO5 Ramp").

50. "BO5 DIRREV"

	Default:	dir (Direct)
	Range:	dir (Direct), rEV (Reverse)

This option does not appear if the signal ramp for BO5 is set to **OFF** (Step 46, "BO5 Ramp") and if the signal type for BO5 is set to **tPm** (Step 47, "BO5 Signal Type"). Set the direction of the binary signal to either Direct or Reverse.

51. "BO5 CONTACT DELAY MINUTES"

	Default:	0 minute
	Range:	0 to 15 minutes
	Increment:	1 minute

This option does not appear if the signal ramp for BO5 is set to **OFF** (Step 46, "BO5 Ramp") and if the signal type for BO5 is set to **tPm** (Step 47, "BO5 Signal Type"). Select the closing delay for BO5 output.

Binary Output 6 (BO6)

The Binary Output 6 settings appear only if you have selected either **FAN**, **VFdt** or **VFdP** at Step 13, "**AO2 RAMP**".

52. "BO6 RAMP"

	Default:	OFF
	Range:	Cr1, Cr2, Hr1, Hr2 (heat with fan), Hr2 (heat without fan), CH1, HU, CO2, 6w, dto, VFdt, VFdP, OFF, COr

Select the desired ramp from the available options. Same as BO3 options. The VFdt and VFdP options are available only if you have selected them at Step 13, "AO2 Ramp".

If you select **OFF**, Steps 53 to 57 will not be available.

- *6W (6-way Valve). If selected, the controller will modulate the 6-way valve depending on the heating or cooling demand.*
- *dto (Delta temperature control). If selected, the controller will modulate the ΔT control based on the inlet and outlet temperature of the water inside the fan coil unit.*
- *VFdt (VFD Temp Loop). If selected, the controller will modulate the VFD fan based on the selected temperature input.*
- *VFdP (VFD Pressure Loop). If selected, the controller will modulate the static pressure based on the reading and the pressure setpoint.*

53. "BO6 SIGNAL TYPE"

	Default:	OnOF (On/Off)
	Range:	tPm (Pulsing), OnOF (On/Off)

This option does not appear if the signal ramp for BO6 is set to **OFF** (Step 52, "BO6 Ramp"). Select the signal type for BO6 to either Pulsing or On/Off.

54. "BO6 CLOSE PERCENT"

	Default:	20% of the demand
	Range:	15 to 80%
	Increment:	1%

This option does not appear if the signal ramp for BO6 is set to **OFF** ((Step 52, "BO6 Ramp") and if the signal type for BO6 is set to **tPm** (Step 53, "BO6 Signal Type"). Select the percentage at which you want BO6 to close (at % of demand of the ramp selected at (Step 52, "BO6 Ramp").

55. "BO6 OPEN PERCENT"

	Default:	0% of the demand
	Range:	0 to (BO6 Close)-4%
	Increment:	1%

This option does not appear if the signal ramp for BO6 is set to **OFF** ((Step 52, "BO6 Ramp") and if the signal type for BO6 is set to **tPm** (Step 53, "BO6 Signal Type"). Select the percentage at which you want BO6 to open (at % of demand of the ramp selected at (Step 52, "BO6 Ramp").

56. "BO6 DIRREV"

	Default:	dir (Direct)
	Range:	dir (Direct), rEV (Reverse)

This option does not appear if the signal ramp for BO6 is set to **OFF** ((Step 52, "BO6 Ramp") and if the signal type for BO6 is set to **tPm** (Step 53, "BO6 Signal Type"). Set the direction of the binary signal to either Direct or Reverse.

57. "BO6 CONTACT DELAY MINUTES"

	Default:	0 minute
	Range:	0 to 15 minutes
	Increment:	1 minute

This option does not appear if the signal ramp for BO6 is set to **OFF** ((Step 52, "BO6 Ramp") and if the signal type for BO6 is set to **tPm** (Step 53, "BO6 Signal Type"). Select the closing delay for BO6 output.

Binary Output 7 (BO7)

The Binary Output 7 settings do not appear if the BO3 signal type is set to FLot at Step 34, "BO3 Signal Type".

58. "BO7 RAMP"

	Default:	OFF
	Range:	Cr1, Cr2, Hr1, Hr2 (heat with fan), Hr2 (heat without fan), CH1, HU, CO2, OFF, COr

Select the desired ramp from the available options. Same as BO3 options.
 If you select **OFF**, Steps 59 to 63 will not be available.

59. "BO7 SIGNAL TYPE"

	Default:	OnOF (On/Off)
	Range:	tPm (Pulsing), OnOF (On/Off)

This option does not appear if the signal ramp for BO7 is set to **OFF** (Step 58, "BO7 Ramp"). Select the signal type for BO7 to either Pulsing or On/Off.

60. "BO7 CLOSE PERCENT"

	Default:	20% of the demand
	Range:	15 to 80%
	Increment:	1%

This option does not appear if the signal ramp for BO7 is set to **OFF** (Step 58, "BO7 Ramp") and if the signal type for BO7 is set to **tPm** (Step 59, "BO7 Signal Type"). Select the percentage at which you want BO7 to close (at % of demand of the ramp selected at Step 58, "BO7 Ramp").

61. "BO7 OPEN PERCENT"

	Default:	0% of the demand
	Range:	0 to (BO6 Close)-4%
	Increment:	1%

This option does not appear if the signal ramp for BO6 is set to **OFF** (Step 58, "BO7 Ramp") and if the signal type for BO7 is set to **tPm** (Step 59, "BO7 Signal Type"). Select the percentage at which you want BO7 to open (at % of demand of the ramp selected at Step 58, "BO7 Ramp").

62. "BO7 DIRREV"

	Default:	dir (Direct)
	Range:	dir (Direct), rEV (Reverse)

This option does not appear if the signal ramp for BO7 is set to **OFF** (Step 58, "BO7 Ramp") and if the signal type for BO7 is set to **tPm** (Step 59, "BO7 Signal Type"). Set the direction of the binary signal to either Direct or Reverse.

63. "BO7 CONTACT DELAY MINUTES"

	Default:	0 minute
	Range:	0 to 15 minutes
	Increment:	1 minute

This option does not appear if the signal ramp for BO7 is set to **OFF** (Step 58, "BO7 Ramp") and if the signal type for BO7 is set to **tPm** (Step 59, "BO7 Signal Type"). Select the closing delay for BO7 output.

Proportional and Deadband Settings

64. "CH OVER PROP BAND"

	Default:	2.0°C	[4°F]
	Range:	0.5°C to 5.0°C	[1°F to 9°F]
	Increment:	0.5°C	[1°F]

Select the desired proportional band value of the changeover ramp. The cooling ❄️ and heating 🔥 symbols are also displayed.

65. "CH OVER DEAD BAND"

	Default:	0.3°C	[0.6°F]
	Range:	0.0°C to 5.0°C	[0°F to 9°F]
	Increment:	0.1°C	[0.2°F]

Select the desired dead band value of the changeover ramp. The cooling ❄️ and heating 🔥 symbols are also displayed.

66. "HEAT1PROP BAND"

	Default:	2.0°C	[4°F]
	Range:	0.5°C to 5.0°C	[1°F to 9°F]
	Increment:	0.5°C	[1°F]

Select the desired proportional band value of the heating ramp 1. The heating  symbol is also displayed.

67. "HEAT1DEAD BAND"

	Default:	0.3°C	[0.6°F]
	Range:	0.0°C to 5.0°C	[0°F to 9°F]
	Increment:	0.1°C	[0.2°F]

Select the desired dead band value of the heating ramp 1. The heating  symbol is also displayed.

68. "HEAT2PROP BAND"

	Default:	2.0°C	[4°F]
	Range:	0.5°C to 5.0°C	[1°F to 9°F]
	Increment:	0.5°C	[1°F]

Select the desired proportional band value of the heating ramp 2. The heating  symbol is also displayed.

69. "HEAT2DEAD BAND"

	Default:	0.3°C	[0.6°F]
	Range:	0.0°C to 5.0°C	[0°F to 9°F]
	Increment:	0.1°C	[0.2°F]

Select the desired dead band value of the heating ramp 2. The heating  symbol is also displayed.

70. "COOL1PROP BAND"

	Default:	2.0°C	[4°F]
	Range:	0.5°C to 5.0°C	[1°F to 9°F]
	Increment:	0.5°C	[1°F]

Select the desired proportional band value of the cooling ramp 1. The cooling  symbol is also displayed.

71. "COOL1DEAD BAND"

	Default:	0.3°C	[0.6°F]
	Range:	0°C to 5.0°C	[0°F to 9°F]
	Increment:	0.1°C	[0.2°F]

Select the desired dead band value of the cooling ramp 1. The cooling  symbol is also displayed.

72. "COOL2PROP BAND"

	Default:	2.0°C	[4°F]
	Range:	0.5°C to 5.0°C	[1°F to 9°F]
	Increment:	0.5°C	[1°F]

Select the desired proportional band value of the cooling ramp 2. The cooling  symbol is also displayed.

73. "COOL2DEAD BAND"

	Default:	0.3°C	[0.6°F]
	Range:	0.0°C to 5.0°C	[0°F to 9°F]
	Increment:	0.1°C	[0.2°F]

Select the desired dead band value of the cooling ramp 2. The cooling  symbol is also displayed.

74. "COOLING ANTI CYCLE MINUTES"

	Default:	2 minutes
	Range:	0 to 15 minutes
	Increment:	1 minute

To protect the compressor, set the delay in minutes before activating or reactivating the cooling output. The cooling  symbol is also displayed.

75. "HEATING INTEGRAL TIME IN SECONDS"

	Default:	0 seconds
	Range:	0 to 250 seconds
	Increment:	5 seconds

Set the desired value for heating integration factor compensation. The heating  symbol is also displayed.



76. "COOLING INTEGRAL TIME IN SECONDS"



Default: 0 seconds
Range: 0 to 250 seconds
Increment: 5 seconds

Set the desired value for cooling integration factor compensation. The cooling ❄ symbol is also displayed.

77. "CHLHT SWITCH TIMER MINUTES"



Default: 0 minutes
Range: 0 to 120 minutes
Increment: 1 minute

Time required in minutes before a changeover can take place. The cooling ❄ and heating 🔥 symbols are also displayed.

Universal Input 1 (UI1)

78. "UI1 SIGNAL TYPE"



Default: OFF
Range: OFF, t10.0, SENs, noCL, noHt, OAS, t10V, CO2, OCC, nSb, oVrd, win, door, dFt, FLS, oVht, SEL, FrFb, HU, P10V, t012, dt1t, dt1u, dt0t, dt0u

Select the input signal type for UI1(Universal Input 1).

- OFF. If selected, the controller does not use the input.
- t10.0. If selected, the controller uses a 10kΩ type III external temperature sensor. If you select **t10.0**, Step 88, "EXTERNTEMP SENSOR OFFSET" will be available.
- SENs. If selected, heating mode activates when the temperature read by the external sensor is above the Changeover Setpoint and cooling mode activates when the temperature read by the external sensor is below the Changeover Setpoint. If you select **SENs**, Step 89, "CHOVER SETPOINT" will be available.
- NoCL. If selected, the heating mode activates when the contact is closed and cooling mode activates when the contact is opened.
- NoHt. If selected, the cooling mode activates when the contact is closed and heating mode activates when the contact is opened.
- OAS. If selected, the controller uses a 10kΩ type III outside air sensor. Note that the temperature read cannot be used as the control temperature.
- t10v. If selected, the controller uses a 0 to 10 Vdc external temperature sensor. If you select **t10v**, Step 79, "UI1 MINIMUM VOLTAGE", 86, "EXTERNTEMP MINIMUM", 87, "EXTERNTEMP MAXIMUM", 88, "EXTERNTEMP SENSOR OFFSET" will be available.
- CO2. If selected, the controller uses a 0 to 10 Vdc CO₂ sensor. If you select **CO2**, Step 90, "CO2 MAXIMUM RANGE" will be available.
- OCC. If selected, the controller activates the occupancy status.
- nSb. If selected, the controller activates the night set back status.
- oVrd. If selected, the controller activates an alarm to indicate that there has been an override and the controller is forced into OFF mode.
- win. If selected, the controller activates an alarm to indicate that the window is open. If you select **win**, Steps 106, "WINDOW OPENMODE" and 107, "WINDOW FANMODE" will be available.
- door. If selected, the controller activates an alarm to indicate that the door is open. If you select **door**, Steps 108, "DOOR OPENMODE" and 109, "DOOR FANMODE" will be available.
- dFt. If selected, the controller activates an alarm to indicate that the filter is dirty.
- FLS. If selected, the controller activates an alarm to indicate that the airflow is absent. The controller shuts off all outputs.
- oVht. If selected, the controller activates an alarm to indicate that the heating equipment has overheated. The controller shuts off the heating outputs.
- SEL. If selected, the controller activates the Local mode. The controller shuts off fan outputs.
- FrFb. If selected, the controller senses the pulse feedback of the ECM motor.
- HU. If selected, the controller activates the humidity mode.
- P10V (Pressure 0-10V). If selected, the controller uses a 0 to 10Vdc pressure static sensor. If you select **P10V**, Step 79, "UI1 Minimum Voltage" and Step 93, "Pressur Maximum Range" will be available.
- t012 (Extern Temp TT012). If selected, the controller uses a 10kΩ type 24 external temperature sensor. If you select **t012**, Step 88, "EXTERNTEMP SENSOR OFFSET" will be available.
- dt1t (Delta Temp Inlet 10K). If selected, the controller uses a 10K type 3 temperature sensor. The controller selects this temperature as the inlet temperature in the ΔT control mode.
- dt1u (Delta Temp Outlet 0-10V). If selected, the controller uses a 0 to 10 Vdc temperature sensor. The controller selects this temperature as the inlet temperature in the ΔT control mode.



- dt0t (Delta Temp Outlet 10K). If selected, the controller uses a 10K type 3 temperature sensor. The controller selects this temperature as the outlet temperature in the ΔT control mode.
- dt0u (Delta Temp Outlet 0-10V). If selected, the controller uses a 0 to 10 Vdc temperature sensor. The controller selects this temperature as the outlet temperature in the ΔT control mode.

If you select one of the following options: **OFF**, **t10.0**, **SEns**, **noCL**, **noHt**, **OAS**, **t10V**, **CO2**, **HU**, **P10V**, or **t012**, Steps 80 and 81 will not be available.



79. "UI1 MINIMUM VOLTAGE"

U11 Default: 2.0
Range: 0.0, 2.0

This option appears only if you have selected either **P10V** or **t10V** at Step 78, "UI1 SIGNAL TYPE". Select the minimum voltage for U11.

80. "UI1 CONTACT"

U11 Default: NO (Normally Open)
Range: NO (Normally Open), NC (Normally Close)

This option appears only if you have selected any one of the options: **OCC**, **nSb**, **oVrd**, **win**, **door**, **dFt**, **FLS**, **oVht**, **SEL** at Step 78, "UI1 SIGNAL TYPE". Select the desired contact option.

81. "UI1 DELAY SECONDS"

U11 Default: 120 seconds
Range: 0 to 3600 seconds
Increment: 10 seconds

This option appears if you have selected any one of the options: **oVrd**, **win**, **door**, **dFt**, **FLS**, **oVht**, **SEL** at Step 78, "UI1 SIGNAL TYPE". Set the delay in seconds before the state of input for U11 is changed.

Universal Input 2 (UI2)

82. "UI2 SIGNAL TYPE"

	Default:	OFF
	Range:	OFF, t10.0, SENs, noCL, noHt, OAS, t10V, CO2, OCC, nSb, oVrd, win, door, dFt, FLS, oVht, SEL, HU, P10V, t012

Select the input signal type for UI2 (Universal Input 2). Same options as Step 78, "UI1 SIGNAL TYPE". The UI1 input signal has priority over UI2. If you select the same input signal type as UI1, UI2 will not be functional.

If you select one of the following options: **OFF**, **noCL**, **noHt**, **OAS** or **HU**, Steps 83 to 92 will not be available.

If you select **t10.0**, Steps 83 to 87 will not be available.

If you select **t10V**, Steps 84 and 85 will not be available.

If you select **SENs**, Steps 83 to 88 will not be available.

If you select **CO2**, Steps 83 to 89 and 93 to 103 will not be available.

If you select **P10V** or **t10V**, Step 83, "UI2 Minimum Voltage" will be available.

If you select **P10V**, Step 93, "Pressur Maximum Range" will be available.

83. "UI2 MINIMUM VOLTAGE"

	Default:	2.0
	Range:	0.0, 2.0

This option appears only if you have selected either **P10V** or **t10V** at Step 82, "UI2 Signal Type". Select the minimum voltage for UI2.

84. "UI2 CONTACT"

	Default:	NO (Normally Open)
	Range:	NO (Normally Open), NC (Normally Close)

This option appears only if you have selected any one of the options: **OCC**, **nSb**, **oVrd**, **win**, **door**, **dFt**, **FLS**, **oVht**, **SEL** at Step 82, "UI2 SIGNAL TYPE". Select the desired contact option.

85. "UI2 DELAY SECONDS"

	Default:	120 seconds
	Range:	0 to 3600 seconds
	Increment:	10 seconds

This option appears if you have selected any one of the options: **oVrd**, **win**, **door**, **dFt**, **FLS**, **oVht**, **SEL** at Step 82, "UI2 SIGNAL TYPE". Set the delay in seconds before the state of input for UI2 is changed.

Temperature Settings

86. "EXTERN TEMP MINIMUM"

	Default:	0°C	[32°F]
	Range:	-40.0°C to 0°C	[-40°F to 32°F]
	Increment:	0.5°C	[1°F]

This option appears only if you have selected **t10V** at Step 78, "UI1 SIGNAL TYPE" or Step 82, "UI2 SIGNAL TYPE". Set the minimum external temperature value. The minimum value is restricted by the maximum value set at Step 87, "EXTERN TEMP MAXIMUM". In other words, the value that is set as the minimum cannot be greater than the maximum value.

87. "EXTERN TEMP MAXIMUM"

	Default:	50°C	[122°F]
	Range:	50°C to 100°C	[122°F to 212°F]
	Increment:	0.5°C	[1°F]

This option appears only if you have selected **t10V** at Step 78, "UI1 SIGNAL TYPE" or Step 82, "UI2 SIGNAL TYPE". Set the maximum external temperature value. The maximum value is restricted by the minimum value set at Step 86, "EXTERN TEMP MINIMUM". In other words, the value that is set as the maximum cannot be less than the minimum value.

88. "EXTERN TEMP SENSOR OFFSET"

	Range:	-40.0°C to 100°C	[-40°F to 212°F]
	Offset:	Max. ± 5°C	[± 9°F]
	Increment:	0.1°C	[0.2°F]

This option appears only if you have selected **t10.0**, **t10V**, or **t012** at Step 78, "UI1 SIGNAL TYPE" or Step 82, "UI2 SIGNAL TYPE". The display shows the temperature read by the external temperature sensor. Adjust the offset by comparing it with a known value (e.g. thermometer). If the sensor is not connected or short circuited, the unit displays the sensor's limit.

89. "CH OVER SETPNT"

Default:	24.0°C	[75°F]
Range:	10.0°C to 40.0°C	[50°F to 104°F]
Increment:	0.5°C	[1°F]

This option appears only if you have selected **SENS** at Step 78, "UI1 SIGNAL TYPE" or Step 82, "UI2 SIGNAL TYPE". Set the desired changeover temperature setpoint. Note that the heating mode activates when the temperature read by the external sensor is above the changeover setpoint and cooling mode activates when the temperature read by the external sensor is below the changeover setpoint.

CO₂ Sensor Settings

The **CO₂ Sensor Settings** appear only for the following conditions: if you have selected **CO2** at Step 78, "UI1 Signal Type" or Step 82, "UI2 Signal Type".

90. "CO2 MAXIMUM RANGE"

Default:	2000 PPM
Range:	100 to 5000 PPM
Increment:	50 PPM

Select the maximum range value for carbon dioxide (CO₂).

91. "CO2 SETPNT"

Default:	800 PPM
Range:	100 to 2000 PPM
Increment:	10 PPM

Indicates the maximum limit of the CO₂ concentration beyond which an alarm is activated. The setpoint value is restricted by the maximum range at Step 90, "CO2 Maximum Range".

92. "DISPLAY CO2"

Default:	No (Disable)
Range:	No (Disable), YES (Enable)

Select whether to enable or disable the display of the CO₂ value.

VFD Pressure Settings

The **VFD Pressure Settings** appear only if you have selected **VFdP** at Step 13, "AO2 Ramp" and **P10V** at Step 78, "UI1 SIGNAL TYPE" or Step 82, "UI2 Signal Type".

93. "PRESSUR MAXIMUM RANGE"

Default:	2000 Pa
Range:	200 to 200.0 Pa
Increment:	50 Pa

This option appears if you have selected **P10V** at Step 78, "UI1 SIGNAL TYPE" or Step 82, "UI2 Signal Type". Select the maximum range for pressure. If the value is higher than 10,000, the value will be divided by 100 and shows a decimal point. For example, 10,000 will be displayed as **100.0** and 10050 will be displayed as **100.5**.

94. "VFD PRESSUR SETPNT"

Default:	500 Pa
Range:	100 to pressure maximum range (value set at Step 93)
Increment:	1 Pa

Select the setpoint value for VFD pressure. If the value is higher than 10,000, the value will be divided by 100 and shows a decimal point. The increment is displayed as 0.1. The fan  symbol is also displayed.

95. "VFD PRESSUR DEAD BAND"

Default:	50 Pa
Range:	0 to 100 Pa
Increment:	1 Pa

Select the desired dead band value for VFD pressure. The fan  symbol is also displayed.

96. "VFD PRESSUR PROP BAND"

Default:	200 Pa
Range:	100 to 500 Pa
Increment:	1 Pa

Select the desired proportional band value for VFD pressure. The fan  symbol is also displayed.



97. "VFD PRESSUR INTGRAL SECONDS"



Default: 0 seconds
Range: 0 to 250 seconds
Increment: 5 seconds

Set the desired value for VFD pressure integral seconds. The fan symbol is also displayed.

VFD Temperature Settings

The VFD Temperature Settings appear only if you have selected VFdt at Step 13, "AO2 Ramp".

98. "VFD TEMP SETPNT SOURCE"



Default: VFd (VFD Temp Setpoint)
Range: VFd (VFD Temp Setpoint), CtrlL (User Temp Setpoint)

Select the desired setpoint source for the VFD temperature control. The fan symbol is also displayed.

99. "VFD TEMP SETPNT"



Default: 22.0°C [72°F]
Range: 10.0°C to 40.0°C [50°F to 104°F]
Increment: 0.5°C [1°F]

Select the desired VFD temperature setpoint. The fan symbol is also displayed.

100. "VFD TEMP DEAD BAND"



Default: 0.3°C [0.6°F]
Range: 0.0°C to 5.0°C [0°F to 9°F]
Increment: 0.1°C [0.2°F]

Select the desired VFD temperature dead band value. The fan symbol is also displayed.

101. "VFD TEMP PROP BAND"



Default: 2.0°C [3.6°F]
Range: 0.5°C to 5.0°C [1°F to 9°F]
Increment: 0.1°C [0.2°F]

Select the desired VFD temperature proportional band value. The fan symbol is also displayed.

102. "VFD TEMP INTGRAL SECONDS"



Default: 0 seconds
Range: 0 to 250 seconds
Increment: 5 seconds

Set the desired value for VFD temperature integral seconds. The fan symbol is also displayed.

103. "VFD TEMP CONTROL SOURCE"



Default: itS (internal)
Range: itS (internal), EtS (External)

Select the source for VFD temperature control.

- *itS.* If selected, the controller will be controlled by its internal temperature sensor.
- *EtS.* If selected, the controller will be controlled by an external temperature sensor.

Temperature Control Source Settings

104. "TEMP CONTROL SOURCE"



Default: itS (internal)
Range: itS (internal), EtS (External), nEt (Network)

Select the source for temperature control.

- *itS.* If selected, the controller will be controlled by its internal temperature sensor.
- *EtS.* If selected, the controller will be controlled by an external temperature sensor.
- *nEt.* If selected, the controller will be controlled by the temperature sent via the BMS.

If you select **itS** or **EtS**, Step 105, "Network Timeout Minutes" will not be available.

If you select **nEt**, Step 105, "Network Timeout Minutes" will be available.

105. "NETWORK TIMEOUT MINUTES"

Default: 5 minutes
 Range: 0 to 60 minutes
 Increment: 1 minute

This option appears only if you have selected **nEt** at Step 104, "TEMP CONTROL SOURCE". Select the duration in minutes after which the controller will go to OFF mode if it does not receive the temperature value via BMS.

Window and Door Settings
106. "WINDOW OPEN MODE"



Default: StP (Setpoint/override enabled)
 Range: StP (Setpoint/override enabled), OFF

This option appears only if you have selected **win** at Step 78, "UI1 SIGNAL TYPE" or Step 82, "UI2 Signal Type". The alarm  symbol is also displayed.

- *StP. If selected, the controller uses the NSB/No Occupancy setpoints when the window is open.*
- *OFF. If selected, the controller is forced into OFF mode when the window is open.*

107. "WINDOW FAN MODE"

Default: AUto (Automatic)
 Range: AUto (Automatic), LO (Low), mEd (Medium), HI (High)

This option appears only if you have selected **win** at Step 78, "UI1 SIGNAL TYPE" or Step 82, "UI2 Signal Type". Select the fan speed mode when the window is open. The fan  and alarm  symbols are also displayed.

108. "DOOR OPEN MODE"



Default: StP (Setpoint/override enabled)
 Range: StP (Setpoint/override enabled), OFF

This option appears only if you have selected **door** at Step 78, "UI1 SIGNAL TYPE" or Step 82, "UI2 Signal Type".

- *StP. If selected, the controller uses the NSB/No Occupancy setpoints when the door is open.*
- *OFF. If selected, the controller is forced into OFF mode when the door is open.*

109. "DOOR FAN MODE"

Default: AUto (Automatic)
 Range: AUto (Automatic), LO (Low), mEd (Medium), HI (High)

This option appears only if you have selected **door** at Step 78, "UI1 SIGNAL TYPE" or Step 82, "UI2 Signal Type". Select the fan speed when the door is open. The fan  and alarm  symbols are also displayed.

Night Set Back (NSB)
110. "NSB OVERRIDE DELAY MINUTES"

Default: 120 minutes
 Range: 0 to 180 minutes
 Increment: 15 minutes

This option appears only if you have selected **nSb** at Step 78, "UI1 SIGNAL TYPE" or Step 82, "UI2 Signal Type". When in Night Set Back (NSB) Mode, the user can override Night Set Back (NSB) (see page 35) for the duration of this delay. To disable night set back override, set the delay to 0. The moon  symbol is displayed to indicate Night Set Back (NSB) Mode.

111. "NSB FAN MODE"

Default: AUto (Automatic)
 Range: AUto (Automatic), LO (Low), mEd (Medium), HI (High)

This option appears only if you have selected **nSb** at Step 78, "UI1 SIGNAL TYPE" or Step 82, "UI2 Signal Type". Select the fan speed mode for night set back. The fan  symbol is also displayed.

112. "NSB MODE"

Default: StP (Setpoint/override enabled)
 Range: StP (Setpoint/override enabled), OFF

This option appears only if you have selected **nSb** at Step 78, "UI1 SIGNAL TYPE" or Step 82, "UI2 Signal Type".

- *StP. If selected, the controller uses the NSB setpoints when in Night Set Back (NSB) Mode. (see page 35).*
- *OFF. If selected, the controller is forced into OFF mode when in Night Set Back (NSB) Mode. (see page 35).*



113. "NSB HEATING SETPNT"

	Default:	16°C	[61°F]
	Range:	10°C to 40°C	[50°F to 104°F]
	Increment:	0.5°C	[1°F]

This option appears only if you have selected **nSb** at Step 78, "UI1 SIGNAL TYPE" or Step 82, "UI2 Signal Type". Set the heating setpoint that will be used when the system is in Night Set Back (NSB) Mode (see page 35). The heating setpoint value is restricted by the cooling setpoint value at Step 114, "NSB COOLING SETPNT". The moon ☾ and heating ⬆ symbols are also displayed.

114. "NSB COOLING SETPNT"

	Default:	28°C	[82°F]
	Range:	10°C to 40°C	[50°F to 104°F]
	Increment:	0.5°C	[1°F]

This option appears only if you have selected **nSb** at Step 78, "UI1 SIGNAL TYPE" or Step 82, "UI2 Signal Type". Set the cooling setpoint that will be used when the system is in Night Set Back (NSB) Mode (see page 35). The cooling setpoint value is restricted by the heating setpoint value at Step 113, "NSB HEATING SETPNT". The moon ☾ and cooling ❄ symbols are also displayed.

Occupancy (OCC)

115. "OCC MINIMUM TIME IN MINUTES"

	Default:	30 minutes
	Range:	0 to 720 minutes
	Increment:	1 minute

This option appears only if you have selected **OCC** at Step 78, "UI1 SIGNAL TYPE" or Step 82, "UI2 Signal Type". Set the minimum time in minutes the controller must remain in the occupied state before it can be enabled to enter or re-enter the No Occupancy Mode (see page 35). The moon ☾ symbol is also displayed.

116. "NO OCC OVERRIDE DELAY MINUTES"

	Default:	120 minutes
	Range:	0 to 180 minutes
	Increment:	15 minutes

This option appears only if you have selected **OCC** at Step 78, "UI1 SIGNAL TYPE" or Step 82, "UI2 Signal Type". When in no occupancy mode, the user can override the No Occupancy Mode (see page 35) up to the duration of this delay by pressing the button. To disable the no occupancy override, set the delay to 0. The moon ☾ symbol is displayed to indicate the No Occupancy Mode.

117. "NO OCC FAN MODE"

	Default:	AUto (Automatic)
	Range:	AUto (Automatic), LO (Low), mEd (Medium), HI (High)

This option appears only if you have selected **OCC** at Step 78, "UI1 SIGNAL TYPE" or Step 82, "UI2 Signal Type". Select the fan speed mode for no occupancy mode. The fan symbol is also displayed.

118. "NO OCC MODE"

	Default:	StP (Setpoint/override enabled)
	Range:	StP (Setpoint/override enabled), OFF

This option appears only if you have selected **OCC** at Step 78, "UI1 SIGNAL TYPE" or Step 82, "UI2 Signal Type". The moon ☾ symbol is also displayed.

- **StP.** If selected, the controller uses the No OCC setpoints when in No Occupancy Mode (see page 35).
- **OFF.** If selected, the controller is forced into OFF mode when in No Occupancy Mode (see page 35).

If you select **OFF**, Steps 119 and 120 will not be available.

119. "NO OCC HEATING SETPNT"

	Default:	16°C	[61°F]
	Range:	10°C to 40°C	[50°F to 104°F]
	Increment:	0.5°C	[1°F]

This option appears only if you have selected **OCC** at Step 78, "UI1 SIGNAL TYPE" or Step 82, "UI2 Signal Type". Set the heating setpoint that will be used when the system is in Night Set Back (NSB) Mode/No Occupancy Mode/Window Open Mode/Door Open Mode. The heating setpoint value is restricted by the cooling setpoint value at Step 120, "NO OCC COOLING SETPNT". The moon ☾ and heating ⬆ symbols are also displayed.



120. "NO OCC COOLING SETPNT"

	Default:	28°C	[82°F]
	Range:	10°C to 40°C	[50°F to 104°F]
	Increment:	0.5°C	[1°F]

This option appears only if you have selected **OCC** at Step 78, "UI1 SIGNAL TYPE" or Step 82, "UI2 Signal Type". Set the cooling setpoint that will be used when the system is in Night Set Back (NSB) Mode/No Occupancy Mode/Window Open Mode/Door Open mode. The cooling setpoint value is restricted by the heating setpoint value at Step 119, "No OCC Heating Setpnt". The moon ☾ and cooling ❄ symbols are also displayed.

Humidity Settings

The Humidity Settings appear only for the following conditions: if you have selected **HU** at Step 78, "UI1 Signal Type" or Step 82, "UI2 Signal Type" or for the models with the built-in humidity sensor, unless otherwise specified.

121. "EXTERN HUMIDTY SENSOR OFFSET"

	Offset:	± 5%
	Range:	10% RH to 90% RH
	Increment:	0.1% RH

This option appears only if you have selected **HU** at Step 78, "UI1 Signal Type" or Step 82, "UI2 Signal Type". The display shows the relative humidity percentage read by the external humidity sensor. Adjust the offset by comparing it with a known value humidistat. If the sensor is not connected or short circuited, unit displays the sensor's limits. The humidify 💧 symbol is also displayed.

122. "INTERN HUMIDTY SENSOR OFFSET"

	Offset:	± 5%
	Range:	10% RH to 90% RH
	Increment:	0.1% RH

This option appears only for the models with the humidity sensor. Compare the displayed humidity percentage reading with a known value from a humidistat. This is useful for the humidistats installed in areas where the humidity reading is slightly different than the room's actual humidity. For example, a humidistat placed right under the air diffuser. The humidify 💧 symbol is also displayed.

123. "HUMIDTY CONTROL MODE"

	Default:	OFF
	Range:	OFF, Auto (Automatic humidify and dehumidify), dEHU (dehumidify only), Hu (humidify only)

- OFF (Disabled). If selected, the controller disables all humidify and dehumidify functions.
- AuTo (Automatic humidify and dehumidify). If selected, the ramp of at least one analog or binary output must be set to Hu (humidify) and another output must be set to COOL (cooling).
- dEHU (Dehumidify only). If selected, the ramp of at least one analog or binary output must be set to COOL (cooling).
- Hu (Humidify only). If selected, the ramp of at least one analog or binary output must be set to Hu (humidify).

If you select **OFF**, Steps 126 to 135 will not be available.

If you select **Hu** or **deHU**, Step 126, "Humidity User Setpnt Minimum" will be available.

124. "DISPLAY HUMIDITY"

	Default:	No
	Range:	No, Yes

This option appears only if you have selected **OFF** at Step 123, "Humidity Control Mode". Select whether to display humidity value or not. If set to No, the controller will not show the humidity value and if set to Yes, it will display the humidity value.

125. "HUMIDITY CONTROL SOURCE"

	Default:	irh
	Range:	Erh, irh

This option appears only for models with the built-in humidity sensor, while also having selected **HU** at Step 78, "UI1 Signal Type" or Step 82, "UI2 Signal Type". Select the source for humidity control.

- irh. If selected, the controller will be controlled by its internal humidity sensor.
- Erh. If selected, the controller will be controlled by an external humidity sensor.

126. "HUMIDTYUSER SETPNT MINIMUM"

Default: 30% RH
 Range: 10% RH to 90% RH
 Increment: 0.5% RH

This option appears only if you have selected **AuTo**, **Hu** or **deHU** at Step 123, "HUMIDTY CONTROL MODE". In Operation Mode, you cannot decrease the setpoint to less than the value set as the minimum humidity setpoint. The minimum value is restricted by the maximum value set at Step 127, "HUMIDTY USER SETPNT MAXIMUM". In other words, the value that is set as the minimum cannot be greater than the maximum value.

127. "HUMIDTY USER SETPNT MAXIMUM"

Default: 65% RH
 Range: 10% RH to 90% RH
 Increment: 0.5% RH

This option appears only if you have selected **AuTo**, **Hu** or **deHU** at Step 123, "HUMIDTY CONTROL MODE". In Operation mode, you cannot increase the setpoint to more than the value set as the maximum humidity setpoint. The maximum value is restricted by the minimum value set at Step 126, "HUMIDTY USER SETPNT MINIMUM". In other words, the value that is set as the maximum cannot be less than the minimum value.

128. "HUMIDTY USER SETPNT LOCKED"

Default: No (Unlocked)
 Range: No (Unlocked), Yes (Locked)

This option appears only if you have selected **AuTo**, **Hu** or **deHU** at Step 123, "HUMIDTY CONTROL MODE". If set to **No**, the user setpoint option is not locked and the user can adjust the desired humidity setpoint. If set to **Yes**, the user setpoint option is locked and the user cannot set the desired humidity setpoint. A lock  symbol appears to indicate that the setpoint is locked.



129. "HUMIDTY USER SETPNT"

Default: 40% RH
 Range: 10% RH to 90% RH
 Increment: 0.5% RH

This option appears only if you have selected **AuTo**, **Hu** or **deHU** at Step 123, "HUMIDTY CONTROL MODE". Set the desired humidity setpoint. If the setpoint option was locked at Step 128, "HUMIDTY USER SETPNT LOCKED", a lock  symbol is displayed. The setpoint value is restricted by the minimum at Step 126, "HUMIDTY USER SETPNT MINIMUM" and maximum at Step 127, "HUMIDTY USER SETPNT MAXIMUM" values.



130. "NSB HUMIDIF SETPNT"

Default: 30% RH
 Range: 10% RH to 65% RH
 Increment: 0.5% RH

This option appears only if you have selected **AuTo**, **Hu** or **deHU** at Step 123, "HUMIDTY CONTROL MODE", and also **nSb** at Step 78, "UI1 SIGNAL TYPE" or Step 82, "UI2 Signal Type". Adjust the humidify setpoint during Night Set Back (NSB) Mode. The humidify setpoint is restricted by the dehumidify value at Step 131, "NSB DEHUMI-SETPNT". The moon  and humidify  symbols are also displayed.



131. "NSB DEHUMI-SETPNT"

Default: 45% RH
 Range: 10% RH to 65% RH
 Increment: 0.5% RH

This option appears only if you have selected **AuTo**, **Hu** or **deHU** at Step 123, "HUMIDTY CONTROL MODE", and also **nSb** at Step 78, "UI1 SIGNAL TYPE" or Step 82, "UI2 Signal Type". Adjust the dehumidify setpoint during Night Set Back (NSB) Mode. The dehumidify setpoint is restricted by the humidify setpoint at Step 130, "NSB HUMIDIF SETPNT". The moon  and dehumidify  symbols are also displayed.

132. "NO OCC HUMIDIF SETPNT"

Default: 30% RH
 Range: 10% RH to 65% RH
 Increment: 0.5% RH

This option appears only if you have selected **AuTo**, **Hu** or **deHU** at Step 123, "HUMIDTY CONTROL MODE", and also **OCC** at Step 78, "UI1 SIGNAL TYPE" or Step 82, "UI2 Signal Type". Adjust the humidify setpoint during No Occupancy Mode. The humidify setpoint is restricted by the dehumidify value at Step 133, "NO OCC DEHUMI-SETPNT". The moon  and humidify  symbols are also displayed.

133. "NO OCC DEHUMI - SETPNT"

Default: 45% RH
 Range: 10% RH to 65% RH
 Increment: 0.5% RH

This option appears only if you have selected **AuTo**, **Hu** or **deHU** at Step 123, "HUMIDITY CONTROL MODE", and also **OCC** at Step 78, "UI1 SIGNAL TYPE" or Step 82, "UI2 Signal Type". Adjust the dehumidify setpoint during No Occupancy Mode. The dehumidify setpoint is restricted by the humidify setpoint at Step 132, "NO OCC HUMIDIF SETPNT". The moon ☾ and dehumidify ☹ symbols are also displayed.

134. "HUMIDTY PROP RAMP"

Default: 5% RH
 Range: 3% RH to 10% RH
 Increment: 0.5% RH

This option appears only if you have selected **AuTo**, **Hu** or **deHU** at Step 123, "HUMIDITY CONTROL MODE". Set the desired proportional ramp value for the humidity control. This value applies to both humidification and dehumidification.

135. "HUMIDTY DEAD BAND"

Default: 1% RH
 Range: 0% RH to 5% RH
 Increment: 0.5% RH

This option appears only if you have selected **AuTo**, **Hu** or **deHU** at Step 123, "HUMIDITY CONTROL MODE". Set the desired dead band value for the humidity control. This value applies to both humidification and dehumidification.

Anti Freeze

136. "ENABLE ANTI FREEZE PROTECT"

Default: No (Disable)
 Range: No (Disable), Yes (Enable)

If this option is enabled, heating starts automatically when the temperature drops to 4°C [39°F], even if the controller is in Cooling or OFF mode. Once the temperature reaches 5°C [41°F], the heating stops.

Delta Temperature

137. "ENABLE DELTA TEMP MODE"

Default: OFF
 Range: On, OFF

Select whether to enable or disable the ΔT control based on the inlet and outlet temperature of the water inside the fan coil unit.

138. "DELTA TEMP SETPNT"

Default: 5°C [41°F]
 Range: -12°C to 12°C [10.4°F to 53.6°F]
 Increment: 0.01°C [0.018°F]

This option appears only if you have selected **On** at Step 137, "ENABLE DELTA TEMP MODE". Set the desired value of the setpoint for the ΔT temperature control mode.

Backlight and Contrast Adjustment

139. "USER BACK LIGHT ADJUST" OR "USER CONTRAST ADJUST"

Default: 50
 Range: 0 to 100
 Increment: 5

Select the backlight or contrast level in the user mode (controller is in operation). Use the ▲ and ▼ buttons to increase or decrease the backlight or contrast level.

140. "OCC BACK LIGHT ADJUST" OR "OCC CONTRAST ADJUST"

Default: 50
 Range: 0 to 100
 Increment: 5

Select the backlight or contrast level in the occupied mode (controller is idle and occupancy state is active). Use the ▲ and ▼ buttons to increase or decrease the backlight or contrast level.

141. "NO OCC BACKLIGHT ADJUST" OR "NO OCC CONTRAST ADJUST"

	Default:	50
	Range:	0 to 100
	Increment:	5

Select the backlight or contrast level in the not occupied mode (controller is idle and occupancy state is inactive). Use the ▲ and ▼ buttons to increase or decrease the backlight or contrast level.

Network Settings
142. "SELECT NETWORK PROTO"

	Default:	bAC (BACnet)
	Range:	bAC (BACnet), mOd (Modbus)

Select the desired network protocol.

BACnet
143. "BACNET AUTO BAUDS RATE"

	Default:	Yes (Enabled)
	Range:	Yes (Enabled), No (Disabled)

Enable or disable Auto Baud Rate Detection. When enabled, the controller automatically configures its baud rate by detecting the network speed upon connection to the network.

144. "BACNET BAUDS RATE"

	Default:	No default (information display only)
	Range:	9.6k, 19.2k, 38.4k, 76.8k

If you enabled Auto Baud Rate Detection at Step 143, "BACNET AUTO BAUDS RATE" the controller displays the automatically detected baud rate.

145. "MSTP MAC ADDRESS"

	Default:	0
	Range:	0 to 254
	Increment:	1

Select the desired MSTP MAC Address. Each device on the network must have a unique MAC address.

146. "MSTP MAX MASTER"

	Default:	127
	Range:	1 to 127
	Increment:	1

Select the desired MSTP MAX address for the master device.

147. "COPY CONFIG"

	Default:	No (Disable)
	Range:	No (Disable), Yes (Enable)

Select **Yes** to copy the configuration of the existing device to other devices of the same type on the network. If you select **No**, go to Step 151, "ADJUST DEVICE INSTANCE 0153000".

148. "SELECT BEGIN ADDRESS"

	Default:	0
	Range:	0 to 254
	Increment:	1

Select the first address you want to copy to. For example, if you select MAC address 1 as the "begin address" and 54 as the "end address", all the devices from 1 to 54 will receive the configuration of the current device.

149. "SELECT END ADDRESS"

	Default:	"begin address"
	Range:	"begin address" + 63
	Increment:	1

Select the last address you want to copy to. You cannot copy more than 64 addresses at once.

150. "COPY CONFIG"

Range: "Copy Config" followed by one of these results:
 "Succeed", "Progerr", "Typeerr", "Modlerr", "Memerr", "Slave", "Commerr"

Displays "Succeed" if the addresses have been copied successfully. Otherwise, an error message appears with the associated MAC address. You can scroll through the addresses and see the error message associated with each address. See below for a complete list of error messages. "copy config succeed"
 Copy config was successful.

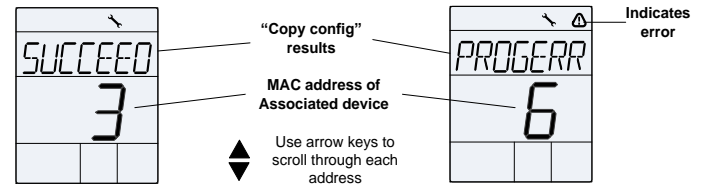
"copy config progerr"

Copy config failed because the target device is in Program Mode.

"copy config typeerr"

Copy config failed because the target device is not the same as the source device. For example, copying an EVC configuration to an EFC device.

copy config modlerr"

Copy config failed because the model number of the source device and the target device is not the same. For example, copying a TSUB configuration to an EFCB.

"copy config mem err"

Copy config failed because the software/application version of the source device and the target device is not the same.

"copy config Slave"

The target device has a slave address and it cannot respond to the master. Manually verify that the configuration was copied correctly or avoid using a slave address (128 - 254).

"copy config commerr"

Copy config failed because the target device did not respond after 3 attempts. Either the address does not exist or there is a problem with the wiring or with noise.



151. "ADJUST DEVICE INSTANCE 0153000"

Default: No
 Range: No, Yes

To change the device instance, select **Yes** and continue to the next step. If you select **No**, the device instance will be modified automatically according to the MAC address (the menu starts over at Step 1, "INTERNTEMPSENSOROFFSET").

152. "0153000"

Default: "current value"
 Range: 0 to 4194302
 Increment: 1

Use the arrow keys to change the value and press the  button to move to the next digit or press  to move to the previous digit. Ensure that you provide a unique device instance.

Modbus
153. "MODBUS AUTO BAUDS RATE"

Default: Yes (Automatic)
 Range: No (Manual), Yes (Automatic)

Enable or disable Modbus Auto Baud Rate Detection. When enabled, the controller automatically configures its baud rate by detecting the network speed upon connection to the network.

154. "MODBUS BAUDS RATE"

Default: No default (information display only)
 Range: 9.6k, 19.2k, 38.4k, 57.6k

If you enabled Modbus Auto Baud Rate Detection at Step 153, "MODBUS AUTO BAUDS RATE", the controller displays the automatically detected baud rate.

155. "MODBUS COMPORT CONFIG"

Default: NP2s (no parity, 2 stop bits)
 Range: EP1s (even parity, 1 stop bit), OP1s (odd parity, 1 stop bit), NP2s (no parity, 2 stop bits)

Select the desired parity and number of stop bits for the modbus communication.



156. "MODBUS ADDRESS"

Default: 1
Range: 1 to 247
Increment: 1

Select the desired Modbus address. Each device on the network must have a unique Modbus address.

Scheduling Mode Settings

This menu is accessible through normal operation mode. The Mode Selector Jumper (JP1) must be set to the RUN position (Operation Mode).

1. Press and hold the  button for 5 seconds. The "ENTER PASSWORD" screen appears.
2. Enter the password (367) within 1 minute. Use the ▲ and ▼ arrow keys to increase or decrease the value and the  buttons to toggle between the digits. If you enter the wrong password, the controller displays "Error" and returns to Operation Mode.

Use the same menu operations as described in Programming Mode on page 6.

The controller will return to normal mode if you navigate through the entire menu and do not make any selection, or if you do not press any key for 5 minutes. The changed values will be saved automatically.

▲▼ = scroll menu items

Schedul Main Menu
HrS (Time)
dAtE (Date)
Opt (Options)
SCHd (Schedule)
rSt (Reset Schedule)
quit (Exit Menu)

Time

1. "SET TIME DISPLAY FORMAT"



Default: 12
Range: 12 hours, 24 hours

Select the desired time format.

2. "SET HOURS"



Range: 00 to 23 hours
Increment: 1 hour

Select the time in hours.

3. "SET MINUTES"



Range: 0 to 59 minutes
Increment: 1 minute

Select the time in minutes.

Date

4. "ENTER YEAR"



Default: 2020
Range: 2009 to 2099
Increment: 1 year

Select the year.

5. "ENTER MONTH"



Range: 01 to 12
Increment: 1 month

Select the month.

6. "SET DAY"



Range: 01 to 31 days
Increment: 1 day

Select the day.



Options

7. "USED TIME SCHEDUL"



Default: No
Range: Yes, No

Select whether to schedule events or not. If set to No, then you will proceed to the quit option. If set to Yes, then you will proceed to Step 8, "Schedul Default Value".

8. "SCHEDUL DEFAULT VALUE"



Default: OCC
Range: OFF, OCC (Occupancy), nOCC (Non-Occupancy), LOC (Locally)

Select the default occupancy mode for the schedule.

Schedule

9. "SELECT DAY OF WEEK"



Default: mo
Range: mo (Monday), tu (Tuesday), wE (Wednesday), th (Thursday), Fr (Friday), SA (Saturday), Su (Sunday)

Select the day of the week.

10. "E100:00"



Range: E1 to E6,
00 to 23 hours,
00,15, 30, 45 minutes,
OFF, OCC (Occupancy), nOCC (Non-Occupancy), --- (Null), LOC (Locally)
Increment: 1

Set the parameters to schedule an event. Select the event number, followed by the time (hours and minutes) and occupancy mode. If --- (Null) is selected, then the controller will remain turned off and the event will be unused. To exit the Event menu, press the button.

Reset Schedule

11. "RESET SCHEDUL"



Default: nO
Range: yES, nO

Select whether to reset and delete the scheduled events or not.

Network Setup Menu

This menu is accessible through normal operation mode. The Mode Selector Jumper (JP1) must be set to the RUN position (Operation Mode).

1. Press the and keys for 5 seconds. The "ENTER PASSWORD" screen appears.
2. Enter the password (637) within 1 minute. Use the and arrow keys to increase or decrease the value and the , buttons to toggle between the digits. If you enter the wrong password, the controller displays "Error" and returns to Operation Mode.

Use the same menu operations as described in Programming Mode on page 6.

The controller will return to normal mode if you navigate through the entire menu and do not make any selection, or if you do not press any key for 5 minutes. The changed values will be saved automatically.

1. "SELECT NETWORK PROTO" TO "MODBUS ADDRESS"









Range: Steps 142 to 156
Page: Page 28 to 30

These network setup steps are exactly the same as those in the Programming Mode. Please refer to Steps 142 to 156, starting on page 28. When complete, continue to the following step.

Sensor Offset Menu

This menu is accessible through normal operation mode. The Mode Selector Jumper (JP1) must be set to the RUN position (Operation Mode).

1. Press the  and  keys for 5 seconds. The "ENTER PASSWORD" screen appears.
2. Enter the password (372) within 1 minute. Use the  and  arrow keys to increase or decrease the value and the ,  buttons to toggle between the digits. If you enter the wrong password, the controller displays "Error" and returns to Operation Mode.

Use the same menu operations as described in Programming Mode on page 6.

The controller will return to normal mode if you navigate through the entire menu and do not make any selection, or if you do not press any key for 5 minutes. The changed values will be saved automatically.

1. "INTERN TEMP SENSOR OFFSET"

	Range:	0°C to 50°C	[32°F to 122°F]
	Offset:	Max. ± 5°C	[± 9°F]
	Increment:	0.1°C	[0.2°F]

Compare the displayed temperature reading with a known value from a thermometer or other temperature sensing device. To offset or calibrate the sensor, use the arrow buttons to set the desired temperature reading. This is useful for controllers installed in areas where the temperature read is slightly different than the room's actual temperature. For example, a controller placed right under the air diffuser.

2. "EXTERN TEMP SENSOR OFFSET"

	Range:	-40.0°C to 100°C	[-40°F to 212°F]
	Offset:	Max. ± 5°C	[± 9°F]
	Increment:	0.1°C	[0.2°F]

This option appears only if you have selected **t10.0** or **t10V** at Step 78, "UI1 Signal Type" or Step 82, "UI2 Signal Type". The display shows the temperature read by the external temperature sensor. Adjust the offset by comparing it with a known value (e.g. thermometer). If the sensor is not connected or short circuited, the unit displays the sensor's limit.

3. "EXTERN HUMIDITY SENSOR OFFSET"

	Offset:	± 5%
	Range:	10% RH to 90% RH
	Increment:	0.1% RH

This option appears if the controller is set to use an external humidity sensor. The display shows the relative humidity percentage read by the external humidity sensor. Adjust the offset by comparing it with a known value humidistat. If the sensor is not connected or short circuited, unit displays the sensor's limits. The humidify  symbol is also displayed.

4. "VFD PRESSUR SETPNT"

	Default:	500 Pa
	Range:	100 to pressure maximum range
	Increment:	1 Pa

This option appears only if you have selected **VFdP** at Step 13 "AO2 Ramp", and **P10V** at Step 78, "UI1 Signal Type" or Step 82, "UI2 Signal Type". Select the setpoint value for VFD pressure. The fan  symbol is also displayed.

5. "VFD TEMP SETPNT"





	Default:	22.0°C	[72°F]
	Range:	10.0°C to 40.0°C	[50°F to 104°F]
	Increment:	0.5°C	[1°F]

This option appears only if you have selected **VFdt** at Step 13 "AO2 Ramp". Select the setpoint value for VFD pressure. The fan  symbol is also displayed.

Reset to Factory Default Settings



This will erase all actual configurations and replace them with the factory default settings.

1. The Mode Selector jumper (JP1) of the digital room sensor must be set to the "RUN" position (Operation Mode). Refer to the Wiring section on page 3.
2. During the power up sequence of the controller and digital room sensor, press and hold both the [] and  buttons.
3. The "Enter Password" screen appears. Enter **372** within 1 minute by using the arrow keys to increase or decrease the value and the [] and [] buttons to toggle between the digits.
4. Use the arrow buttons to select YES and then press [].

Operation Mode

The Mode Selector Jumper JP1 must be set to the RUN position (Operation Mode). Refer to the Wiring section on page 3.

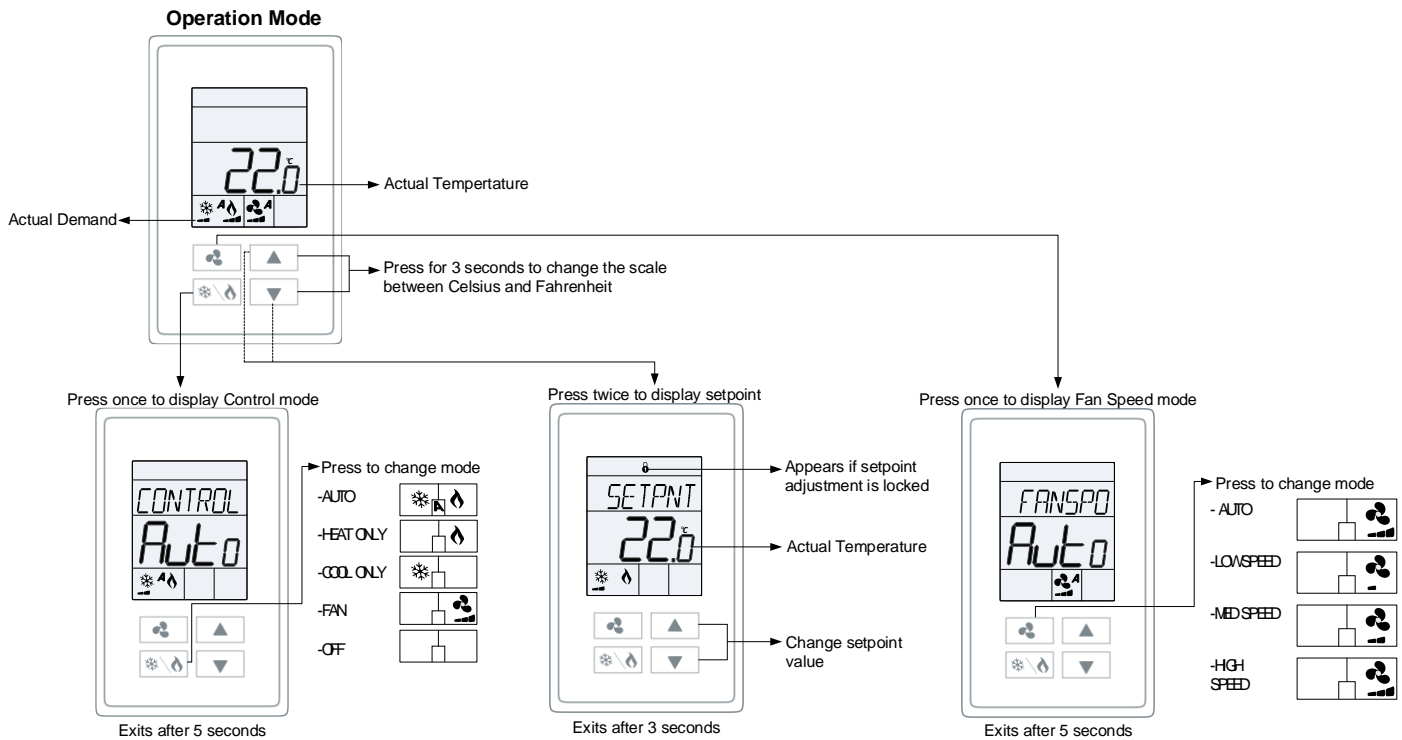

Power Up

Upon power up, the LCD illuminates and all segments appear for 2 seconds. The controller then displays its current version for 2 seconds.

LCD Backlight

Pressing any key illuminates the LCD for 4 seconds.

Default Display

The controller displays temperature and humidity readings or setpoints, with or without demand according to the selection made at Step 8, "Display Info". If a humidity sensor is not used, the temperature values will always be displayed. If a sensor is disconnected or short circuited, then the unit displays the sensor's limits. To toggle the temperature scale between °C and °F, press both the up ▲ and down ▼ arrow keys for 3 seconds.

Temperature Setpoint Display and Adjustment

To display the setpoint, press the ▲ or ▼ key twice. The setpoint appears for 3 seconds. To adjust the setpoint, press the arrow keys while the setpoint is displayed. If the setpoint adjustment has been locked (Step 5, "USERSETPNT"), the lock 🔒 symbol appears.

Humidity Setpoint Display and Adjustment

To access the Humidity setpoint, press the 🌀 button for 5 seconds. The humidity setpoint will be displayed for 5 seconds. To adjust the setpoint, press the ▲ and ▼ keys while the setpoint is displayed. The unit automatically exits this menu if you do not press any key for 3 seconds. The changed values will be saved automatically.

Control Mode



To access the Control Mode, press the 🌀 key. The Control Mode appears for 5 seconds. Press the 🌀 key to scroll through the following control modes. These options can vary depending on the options selected at the following:

- Step 6, "TEMP CONTROL MODE"
- Step 7, "ENABLE ON/OFF CONTROL MODE"
- Step 27, "FAN SPEED OPTION"

- Auto (Automatic Cooling or Heating)
- Cooling only (on, with cooling ❄️ symbol)
- Heating only (on, with heating 🔥 symbol)
- FAN (on, with fan 🌀 symbol)
- OFF (if it is not disabled in Programming Mode)





Fan Speed Selection Mode

To access the Fan Speed selection mode, press the  key. The mode appears for 5 seconds. These options can vary depending on the fan speed signal and auto mode settings at Step 30 "FAN AUTO MODE" and Step 26, "FAN SPD SIGNAL". If in No Occupancy mode, the  button now serves as the override button.

The Fan Speed Selection Mode is not available when VFD analog output is used and if **Yes** is selected at Step 29 "HIDE FAN DISPLAY INFO".





- Automatic speed. This option is available if you have selected **yES** (Enable) at Step 30, "FAN AUTO MODE" in Programming Mode.
- Low speed
- Medium speed
- High speed
- OFF. OFF is not selectable by the user, it appears only if the "Control Mode" is "OFF" and it indicates that the user cannot change the speed of the fan.

Night Set Back (NSB) Mode





This function is only available if you have set input to **nSb** (Night Set Back contact). If the contact is triggered, the controller enters NSB Mode (the  symbol appears) and uses the NSB setpoints defined at Steps 113, "NSB HEATING SETPNT", 114, "NSB COOLING SETPNT" and 111, "NSB FAN MODE". Press any key to override NSB for the delay defined at Step 110, "NSB OVERRIDE DELAY MINUTES". The  symbol flashes to indicate that the NSB mode is overridden (during this time the standard setpoints are used).

No Occupancy Mode

This function is only available if you have set input to **OCC** (occupancy contact). If the contact is triggered and the minimum occupancy time defined at Step 115, "OCC Minimum Time In Minutes" has elapsed, the controller enters No Occupancy Mode (the  symbol appears) and uses the No OCC setpoints defined at Steps 119, "No OCC Heating Setpnt", 120 "No OCC Cooling Setpnt" and 117, "No OCC Fan Mode".

Press the fan  button to override no occupancy. Each time you press the  button, 15 minutes are added to the override up to a maximum defined by Step 116, "No OCC Override Delay Minutes". Press the fan  button until "0" is displayed to disable the override. The  icon will flash and the remaining override time will be displayed in minutes.

Backlight and Contrast Level Adjustment

For models with the grey LCD screen, the backlight level can be adjusted. For models with the black LCD screen, the contrast level can be adjusted. Press and hold the  and  buttons for 5 seconds and enter the password **367** to gain access to the backlight and contrast level adjustment settings. Use the  and  keys to adjust the backlight or contrast level in three modes: User (controller is in operation), Occupied (controller is idle and occupancy state is active) and Not Occupied (controller is idle and occupancy state is inactive). Press the  key to save any changes.



Recycling at end of life: please return this product to your Nepronic local distributor for recycling. If you need to find the nearest Nepronic authorized distributor, please consult www.nepronic.com.



nepronic[®]

400 Lebeau Blvd, Montreal, Qc, H4N 1R6, Canada

www.nepronic.com

Toll free in North America: 1-800-361-2308

Tel.: (514) 333-1433

Fax: (514) 333-3163

Customer service fax: (514) 333-1091

Monday to Friday: 8:00am to 5:00pm (Eastern time)