

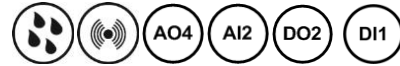

Model
HROB20



Description

The Humidity Controller is a combination controller and humidistat with support for networked communications via the BACnet MS/TP protocol. The Humidity Controller is an advanced application to control relative humidity for general purpose applications. They are specially designed to control humidifiers and dehumidification equipment.

Outputs & Inputs

- 4 analog outputs (0-10 Vdc or 2-10 Vdc)
- 2 dry contact outputs
- External humidity sensor input
- Window or external temperature sensor input
- Alarm status input
- Low signal selector input
- Configurable PID



HROB20

Operation & Display

- BACnet® MS/TP @ 9.6k,19.2k,38.4k,76.8k bps
- Selectable MAC address
- Adjustable setpoint with auto reset from external sensor
- Multi level lockable access menu
- Lockable setpoint and control mode
- Backlit LCD with simple icon and text driven menus
- Selectable Celsius or Fahrenheit scale
- Humidification and dehumidification indicator

Technical Specifications

Description	HROB20
Outputs	<ul style="list-style-type: none"> - Actual humidity (0-100% RH), 0-10 Vdc/2-10 Vdc - Humidity setpoint (0-100% RH), 0-10 Vdc/2-10 Vdc - Humidification proportional control signal, 0-10 Vdc/2-10 Vdc - Dehumidification proportional control signal, 0-10 Vdc/2-10 Vdc - Humidification dry contracts 24 Vac, 1 A max, 3 A in-rush - Dehumidification dry contracts 24 Vac, 1 A max, 3 A in-rush
Inputs	<ul style="list-style-type: none"> - 1 window temperature sensor or outside temperature sensor (10 KΩ) - 1 alarm status digital input (24 Vac or dry contact) - 2 configurable analog inputs (0-10 or 2-10Vdc). Refer to steps 22 and 24 for complete list
Power supply	22 to 26 Vac 50/60 Hz or 28 to 32 Vdc
Power consumption	1 VA
Setpoint range	10%-90% RH (in 1% increments)
Sensor precision	± 3% or better at 40% RH and 23°C [73°F]
Proportional band	2%-10% for control signal
Electrical connection	0.8 mm ² [18 AWG] minimum
Operating condition	0°C to 40°C [32°F to 104°F], 0-95% RH
Storage condition	-10°C to 50°C [14°F to 122°F], 0-95% RH
Temperature compensation reset	Automatic readjustment of setpoint from a window temperature sensor (SHW0-11), or external temperature sensor (STC8-11 for fresh air duct temp or STO2-11 for outside air temp)
Housing degree of protection	IP 30 (EN 60529)
Weight	130 g. [0.3 lb]
Dimensions A = 2.85" 73mm B = 4.85" 123mm C = 1.00" 24mm D = 2.36" 60mm E = 3.27" 83mm	

Wiring

We strongly recommend that all Neptronic products be wired to a separate grounded transformer and that transformer shall service only Neptronic products. This precaution will prevent interference with, and/or possible damage to incompatible equipment. For more information about wiring the humidistat with various humidifiers, refer to the Wiring - Humidistat and Humidifiers section on page 13.

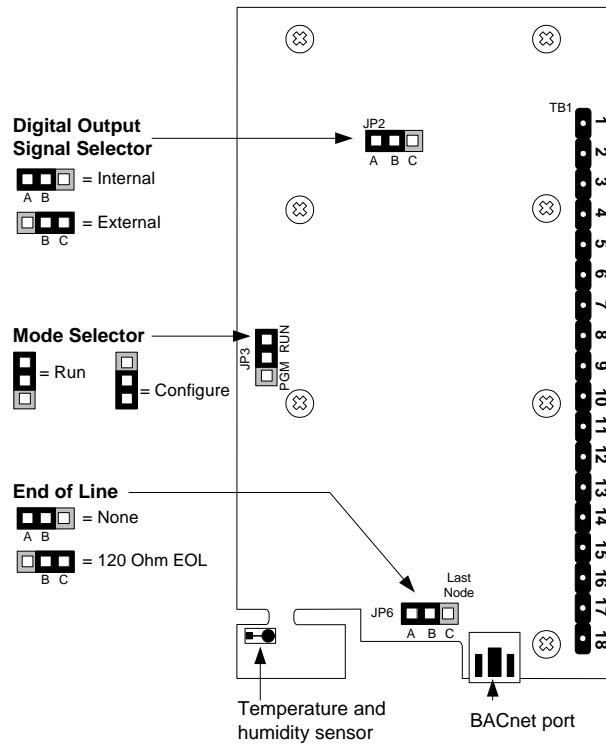

Terminal Description		Details
1	Common	
2	24 Vac or 30 Vdc	
3	Window temperature sensor or outside temperature sensor input (AI3)	see step 38
4-6	Not available	
7	Common Relay	
8	Humidify Contact Output (DO1)	
9	Dehumidify Contact Output (DO2)	
10	Humidify setpoint analog output (AO4) Note: If dehumidify only is selected, AO4 = 0 V	
11	Alarm status digital input (DI1)	
12	(AI1) <ul style="list-style-type: none"> • External setpoint from Neptronic humidifier • External 0-10 or 2-10Vdc signal <ul style="list-style-type: none"> ○ external demand ○ external humidity sensor ○ low signal selector input (LSS) ○ averaging 	see step 22
13	(AI2) <ul style="list-style-type: none"> • External 0-10 or 2-10Vdc signal <ul style="list-style-type: none"> ○ external demand ○ external high limit ○ external duct supply in ○ low signal selector input (LSS) ○ averaging 	see step 24
14	Humidify Analog Output (AO1)	see step 6
15	Dehumidify Analog Output (AO2)	see step 6
16	Actual Humidity Output (0-100% RH) (AO3)	
17	A+	BACnet RS-485
18	B-	BACnet RS-485

Jumpers

Jumpers	Description
JP2 Digital Output Signal Selector	A&B = Internal: Digital output signal is linked to internal 24 Vac (same as humidistat) B&C = External: Digital output signal is linked to external 24 Vac (different than humidistat)
JP3 Mode Selection	A&B = RUN: Humidistat is in Operation Mode. (See Operation Mode page 12) B&C = PGM: Humidistat is in Programming Mode. (See Programming Mode on page 3)
JP6 End of Line	A&B = No end of line B&C = 120 Ohm end of line (on the last of the HROB20 RS-485 communication bus)

Mounting Instructions

CAUTION: Remove power to avoid a risk of malfunction.

- A. Remove the captive screw that's holding the base and the front cover of the humidistat together.
- B. Lift the front cover of the humidistat to separate it from the base.
- C. Pull all wires through the holes in the base.
- D. Secure the base to the wall using wall anchors and screws (supplied). Make the appropriate connections.
- E. Mount the control module on the base and secure using the screw.

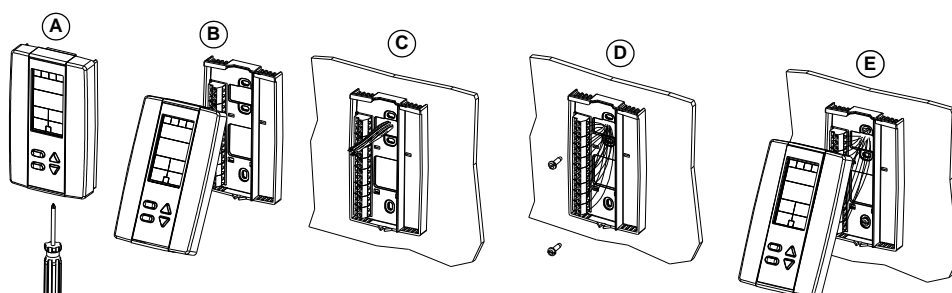





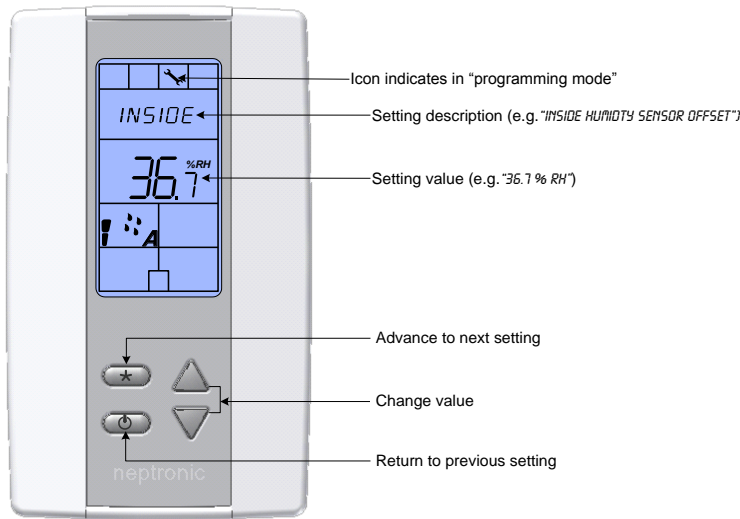



Programming Mode

i The Mode Selector Jumper (JP3) must be set to the "PGM" mode (Programming Mode). Refer to Wiring on page 2. To exit, set the Jumper (JP3) back to the "RUN" mode (Operation Mode). All changes will be saved.



Symbols Used in this Manual

	Humidity		Analog Output 1
	Communication		Analog Output 2
	Temperature		Analog Output 3
	Analog Input 1		Analog Output 4
	Analog Input 2		

Setpoint and User Control

1. "INSIDE HUMIDITY SENSOR OFFSET"

	Range:	10 to 90% RH
	Offset:	Max. $\pm 5\%$
	Increment:	0.1% RH

Compare the displayed humidity reading with a known value from a humidistat. To offset or calibrate the sensor, use the arrow keys to set the desired humidity reading. This is useful for humidistats installed in areas where the humidity read is slightly different than the room's actual humidity. For example, a humidistat placed right under the air diffuser.

2. "INSIDE TEMPER SENSOR OFFSET"

	Range:	10 to 40°C	[50 to 104°F]
	Offset:	Max. $\pm 5\%$	
	Increment:	0.1°C	[0.2°F]

Compare the displayed temperature reading with a known value from a thermometer. To offset or calibrate the sensor, use the arrows key to set the desired temperature reading. This is useful for thermostats installed in areas where the temperature read is slightly different than the room's actual temperature. For example, a thermostat placed right under the air diffuser.

3. "ADJUST MINIMUM USER SETPNT"

	Default:	15% RH
	Range:	10 to 90% RH
	Increment:	1% RH

In Operation Mode, you cannot decrease the setpoint to less than the value set as the minimum humidity setpoint. The minimum value is restricted by the maximum value set in Step 4 "Adjust Maximum User Setpnt". In other words, the value that is set as the minimum cannot be greater than the maximum value.

4. "ADJUST MAXIMUM USER SETPNT"



Default: 65% RH
 Range: 10 to 90% RH
 Increment: 1% RH

In Operation mode, you cannot increase the setpoint to more than the value set as the maximum humidity setpoint. The maximum value is restricted by the minimum value set in Step 3 "Adjust Minimum User Setpnt". In other words, the value that is set as the maximum cannot be less than the minimum value.

5. "USER SETPNT LOCKED"



Default: No (Unlocked)
 Range: No (Unlocked), Yes (locked)

If set to **No**, the user setpoint option is not locked and the user can adjust the desired humidity setpoint. If set to **Yes**, the user setpoint option is locked and the user cannot set the desired humidity setpoint. A lock symbol  appears to indicate that the setpoint is locked.

Humidity Settings

6. "ADJUST CONTROL MODE"



Default: Hu (humidify only)
 Range: Hu (humidify only), AuTo (Automatic humidify and dehumidify), dEHU (dehumidify only)

Select the control mode that you want to authorize to the user. To authorize all the available modes, select **AuTo** (Automatic Mode).

7. "ADJUST HUMIDTY SETPNT"



Default: 40% RH
 Range: 10 to 90% RH
 Increment: 1% RH

Appears only if you have selected Auto or Hu at Step 6 "Adjust Control Mode". Set the desired humidity setpoint. If the setpoint option was locked at Step 5 "User Setpnt Locked", a lock symbol  is displayed. The setpoint value is restricted by the minimum (Step 3) and maximum (Step 4) values.

8. "ADJUST DEHUMI SETPNT"



Default: 50% RH
 Range: 10 to 90% RH
 Increment: 1% RH

Appears only if you have selected Auto or dEHU at Step 6 "Adjust Control Mode". Set the desired dehumidify setpoint. If the setpoint option was locked at Step 5 "User Setpnt Locked", a lock symbol  is displayed. The setpoint value is restricted by the minimum (Step 3) and maximum (Step 4) values.

9. "ENABLE ON OFF CONTROL MODE"



Default: Yes (Enable)
 Range: Yes (Enable), No (Disable)

If you select **Yes**, the user can set the unit to **Off**. If you select **No**, the **Off** selection does not appear. See user Control Mode on page 12.

10. "HUMIDTY CONTROL RAMP"



Default: 5.0% RH
 Range: 2 to 10% RH (recommended); *for special applications, the controller can go to a maximum range of 300%*
 Increment: 0.5% RH

Appears only if you have selected Auto or Hu at Step 6 "Adjust Control Mode". Select the desired span for the humidify ramp. *Proportional* control applies an effort in proportion to how far you are from the setpoint. The closer you get to the setpoint, the less it pushes. A demand of 100% is applied at the beginning of the ramp. For example with a setpoint of 40% and a ramp of 5%, the controller will apply a demand of 100% at 35%RH. The humidify  symbol is also displayed.

11. "DEHUMI CONTROL RAMP"



Default: 5.0% RH
 Range: 2 to 10% RH (recommended); *for special applications, the controller can go to a maximum range of 300%*
 Increment: 0.5% RH

Appears only if you have selected Auto or dEHU at Step 6 "Adjust Control Mode". Select the desired span for the dehumidify ramp. *Proportional* control applies an effort in proportion to how far you are from the setpoint. The closer you get to the

setpoint, the less it pushes. A demand of 100% is applied at the beginning of the ramp. For example with a setpoint of 50% and a ramp of 5%, the controller will apply a demand of 100% at 45%RH. The dehumidify ☹ symbol is also displayed.

12. "CONTROL DEAD BAND"



Default: 0.3% RH
 Range: 0.3 to 50% RH
 Increment: 0.1% RH

Select the desired dead band value for both humidity and dehumidify ramps. The deadband is the interval of the signal band where no action occurs to prevent repeated activation-deactivation cycles. The humidify ☺ and dehumidify ☹ symbols are also displayed. The deadband value applies to both the humidify and dehumidify control ramps (e.g. 0.3% for Hum and 0.3% for Dehum).

13. "HUMIDTY INTGRAL TIME"



Default: 0 minutes
 Range: 0 to 60 minutes
 Increment: 1 minute

Appears only if you have selected Auto or Hu at Step 6 "Adjust Control Mode". Set the integral time for the humidity ramp. The integral control cumulates a factor of the difference between the setpoint and the actual reading in order to give an additional push to the ramp. The humidify ☺ symbol is also displayed.

14. "HUMIDTY DERIVAT TIME"



Default: 0 seconds
 Range: 0.0 to 300.0 seconds
 Increment: 0.5 seconds

Appears only if you have selected Auto or Hu at Step 6 "Adjust Control Mode". Set the derivative time for the humidity ramp. Many, if not most, control applications can run perfectly well with just P and I control. The derivative control adds a factor to time scale in order to dampen or try to predict the control effort. As it approaches the setpoint, it settles with a minimum of overshoot. The humidify ☺ symbol is also displayed.

15. "DEHUMI INTGRAL TIME"



Default: 0 minutes
 Range: 0 to 60 minutes
 Increment: 1 minute

Appears only if you have selected Auto or dEHU at Step 6 "Adjust Control Mode". Set the integral time for the dehumidify ramp. The integral control cumulates a factor of the difference between the setpoint and the actual reading in order to give an additional push to the ramp. The dehumidify ☹ symbol is also displayed.

16. "DEHUMI DERIVAT TIME"



Default: 0 seconds
 Range: 0.0 to 300.0 seconds
 Increment: 0.5 seconds

Appears only if you have selected Auto or dEHU at Step 6 "Adjust Control Mode". Set the derivative time for the dehumidify ramp. Many, if not most, control applications can run perfectly well with just P and I control. The derivative control adds a factor to time scale in order to brake or dampen the control effort. As it approaches the setpoint, it settles in nicely with a minimum of overshoot. The dehumidify ☹ symbol is also displayed.

17. "HUMIDTY DEHUMI LOCKED TIME"



Default: 0 minutes
 Range: 0 to 120 minutes
 Increment: 1 minute

Appears only if you have selected Auto at Step 6 "Adjust Control Mode". Represents a delay before switching from one mode to the other. For example, if set to 2 minutes and the system is currently humidifying, the system will only switch to dehumidification if the demand for dehumidification is active for 2 consecutive minutes.

Analog Outputs (AO1 to AO4)

18. "MIN VDC ANALOG AO1 OUTPUT"



Default: 0.0 Volt
 Range: 0.0 or 2.0 Volt

Appears only if you select Auto or Hu at Step 6 "Adjust Control Mode". Defines the analog signal for AO1 Humidity Analog Output. Select 0.0 for 0-10Vdc or 2.0 for 2-10Vdc. The humidify ☺ symbol is also displayed.

19. "MIN VDC ANALOG AO2 OUTPUT"

AO2 Default: 0.0 Volt
Range: 0.0 or 2.0 Volt

Appears only if you select Auto or dEHU at Step 6 "Adjust Control Mode". Defines the analog signal for AO2 Dehumidification Analog Output. Select 0.0 for 0-10Vdc or 2.0 for 2-10Vdc. The dehumidify ☹ symbol is displayed.

20. "MIN VDC ANALOG AO3 OUTPUT"

AO3 Default: 0.0 Volt
Range: 0.0 or 2.0 Volt

Defines the analog signal range for AO3 (Actual Humidity Output). Select 0.0 for 0-10Vdc or 2.0 for 2-10Vdc. The humidify ☺ symbol is also displayed.

21. "MIN VDC ANALOG AO4 OUTPUT"

AO4 Default: 0.0 Volt
Range: 0.0, 2.0 Volt

Appears only if you select Auto or Hu at Step 6 "Adjust Control Mode". Defines the analog signal for AO4 (Humidity Setpoint). Select 0.0 for 0-10Vdc or 2.0 for 2-10Vdc. Select the desired value of the minimum voltage of AO4 output. The humidify ☺ symbol is also displayed.

Analog Inputs (AI1 and AI2)

22. "SELECT AI1 INPUT SIGNAL"

AI1 Default: OFF (input not used)
Range: OFF, EHS.0, EHS.2, AEr.0, AEr.2, dEd.0, dEd.2, LSS.0, LSS.2, SPS

If an external humidity reading is required, set the input signal type for AI1 (analog input 1) to a value other than OFF. The SPS and LSS options are not available if the control mode is set to "dehumidify" (see step 6).

- **EHS.0 (0-10Vdc) or EHS.2 (2-10Vdc) = External humidity sensor signal**
- **AEr.0 (0-10Vdc) or AEr.2 (2-10Vdc) = External humidity sensor averaging.** If selected, the controller performs an averaging of one of the following combinations depending on the selected options:
 - Average of AI1 and the internal sensor's reading. (set step 36 to YES)
 - Average of AI1 and AI2 (set step 24 to AEr.0 or AEr.2)
 - Average of AI1, AI2 and internal sensor's reading (set step 24 to AEr.0/AEr.2 and set step 36 to YES)
- **dEd.0 (0-10Vdc) or dEd.2 (2-10Vdc) = External Demand signal**
- **If LSS.0 (0-10Vdc) or LSS.2 (2-10Vdc) = External demand low signal selector.** If selected, the controller compares the values of two or three signals and selects the lowest signal. The result of the LSS is provided as an output on AO1 (pin 14).
 - Lowest signal between AI1 and the internal demand (set step 37 to HuLs).
 - Lowest signal between AI1 and AI2 (set step 24 to LSS.0 or LSS.2).
 - Lowest signal between AI1, AI2 and internal demand (set step 24 to LSS.0 or LSS.2 and set step 37 to HuLs)
- **SPS = External humidity setpoint source.** If selected, the controller disables the humidify setpoint (step 7) and uses an external setpoint from a Neptronic humidifier. The external setpoint is used to process the humidity demand.

Input not used



External Humidity Sensor
0-10 Vdc

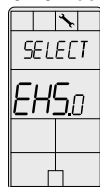

External Humidity Sensor
2-10 Vdc

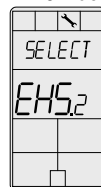

External Humidity Sensor
Averaging (0-10 Vdc)

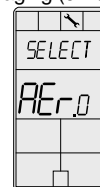

External Humidity Sensor
Averaging (2-10 Vdc)



External Demand
0-10 Vdc



External Demand
2-10 Vdc

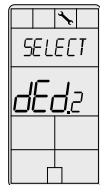

External Demand Low
Signal Selector (0-10 Vdc)

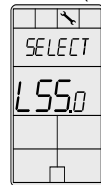

External Demand Low
Signal Selector (2-10 Vdc)

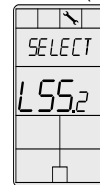

External Setpoint from
Neptronic Humidifier

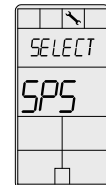

23. "EXTERN HUMIDTY SENSOR 1 OFFSET"



Range: 10 to 90% RH
 Offset: Max. ± 5%
 Increment: 0.1% RH

This option appears if you have selected **EHS.0**, **EHS.2**, **AEr.0**, or **AEr.2**, at Step 22. When the humidistat is connected to analog input (AI1), the display shows the relative humidity percentage read by the external humidity sensor. Adjust the offset by comparing it with a known value humidistat. If the sensor is disconnected or short circuited, then "OFF", "- -", and the alarm symbol are displayed. The humidify  symbol is also displayed.

24. "SELECT AI2 INPUT SIGNAL"



Default: OFF (input not used)
 Range: OFF, dEd.0, dEd.2, AEr.0, AEr.2, LSS.0, LSS.2, HIL.0, HIL.2, dUC.0, dUC.2

Select the input signal type for AI2 (analog input 2). The AEr, LSS, HIL and duC options are not available if the control mode is set to "dehumidify" (see step 6). Please note that if selected options for AI1 and AI2 are similar or conflicting, the AI2 option takes precedence. For example if AI1= EHS and AI2 = AEr, the HRO will ignore the EHS and run using the AEr.

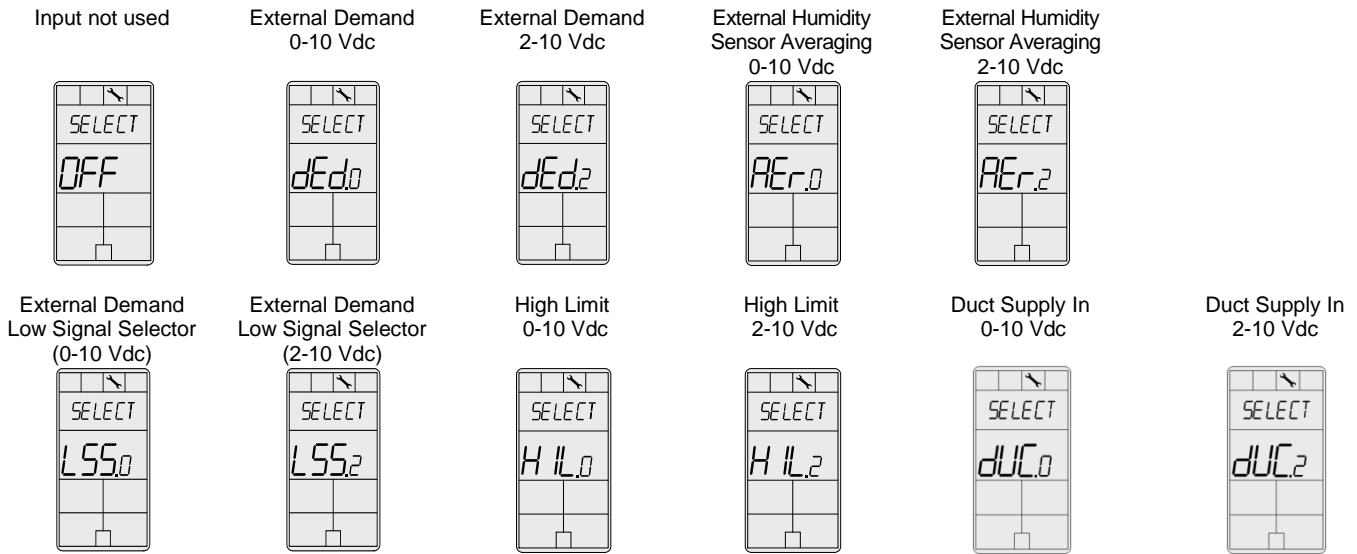

- **AEr.0 (0-10Vdc) or AEr.2 (2-10Vdc) = External humidity sensor averaging.** If selected, the controller performs an averaging of one of the following combinations depending on the selected options:
 - Average of AI2 and the internal sensor's reading (set step 36 to YES)
 - Average of AI2 and AI1 (set step 22 to AEr.0 or AEr.2)
 - Average of AI2, AI1 and internal sensor's reading (set step 22 to AEr.0 or AEr.2 and set step 36 to YES)
- **LSS.0 (0-10Vdc) or LSS.2 (2-10Vdc) = External demand low signal selector.** If selected, the controller compares the values of two or three signals and selects the lowest signal. The result of the LSS is provided as an output on AO1 (pin 14).
 - Lowest signal between AI2 and the internal demand (set step 37 to HuLs)
 - Lowest signal between AI2 and AI1 (set step 22 to LSS.0 or LSS.2)
 - Lowest signal between AI2, AI1 and internal demand (set step 22 to LSS.0 or LSS.2 and set step 37 to HuLs)
- **dEd.0 (0-10Vdc) or dEd.2 (2-10Vdc) = External Demand signal**
- **HIL.0 (0-10Vdc) or HIL.2 (2-10Vdc) = High limit.** If selected, the controller compares the demand of the room humidity PID loop with the duct/high limit PID loop and applies the lower of the two.

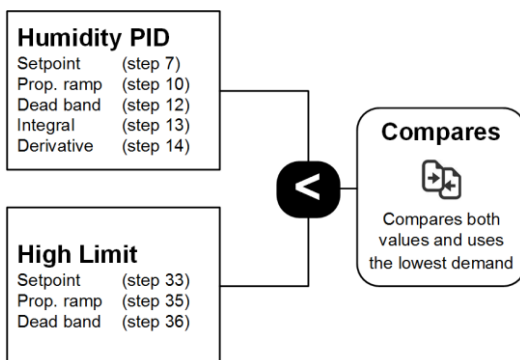



- **dUC.0** (0-10Vdc) or **dUC.2** (2-10Vdc) = **Duct supply input**. If selected, the controller sequentially passes the demand through two PID loops and a zero span to smooth out the signal.

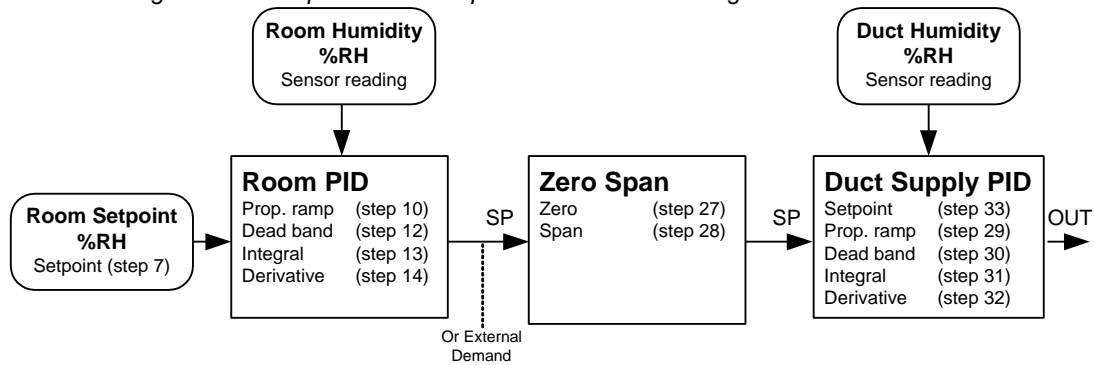

25. "EXTERN HUMIDTY SENSOR 2 OFFSET"



Range: 10 to 90% RH
 Offset: Max. ± 5%
 Increment: 0.1% RH

This option appears if you have selected **AEr.0**, **AEr.2**, **HIL.0**, **HIL.2**, **dUC.0**, or **dUC.2** at Step 24. When the humidistat is connected to analog input (AI2), the display shows the relative humidity percentage read by the external humidity sensor. Adjust the offset by comparing it with a known value humidistat. If the sensor is disconnected or short circuited, then "OFF", "--", and the alarm symbol are displayed. The humidify symbol is also displayed.

26. "HUMIDTY HIGH FILTER TIME"



Default: 8 seconds
 Range: 0 to 32 seconds
 Increment: 1 second

Appears only if **EHS.0**, **EHS.2** is selected at Step 22 or if **HIL.0**, **HIL.2**, **dUC.0**, or **dUC.2** is selected at Step 24.

Duct Supply Ramp (AI2)

27. "ADJUST DUCT SUPPLY ZERO"



Default: 0% RH
 Range: 0 to span (step 28) %RH
 Increment: 1% RH

Appears only if **dUC.0** or **dUC.2** is selected at Step 24. Represents a zero conversion, where a demand of 0% is converted to a minimum setpoint value. For example, if you set this value to 10% and the demand received is 5%, the controller will convert the demand to a setpoint of 14%.

28. "ADJUST DUCT SUPPLY SPAN"



Default: 70% RH
 Range: Duct supply zero (step 27) to 90% RH
 Increment: 1% RH

Appears only if **dUC.0** or **dUC.2** is selected at Step 24. Represents a span conversion, where a demand of 100% is converted to a maximum setpoint value. For example, if you set this value to 70% and the demand received is 80%, the controller will convert the demand to a setpoint of 70%.

29. "ADJUST DUCT SUPPLY RAMP HUMIDTY"



Default: 5.0% RH
 Range: 2 to 10% RH (recommended); for special applications, the controller can go to a maximum range of 300%
 Increment: 0.5% RH

Appears only if **dUC.0** or **dUC.2** is selected at Step 24. Select the desired proportional ramp for the duct supply humidity. Proportional control applies an effort in proportion to how far you are from the setpoint. The closer you get to the setpoint, the less it pushes. A demand of 100% is applied at the beginning of the ramp. For example, with a setpoint of 40% and a ramp of 5%, the controller will apply a demand of 100% at 35% RH. The humidify symbol is also displayed.

30. "DUCT SUPPLY DEAD BAND"



Default: 0.3% RH
 Range: 0.3 to 50% RH
 Increment: 0.1% RH

Appears only if **dUC.0** or **dUC.2** is selected at Step 24. Select the desired dead band value for the duct supply humidity ramp. The deadband is the interval of the signal band where no action occurs to prevent repeated activation-deactivation cycles. The humidify symbol is also displayed.

31. "DUCT SUPPLY INTEGRAL TIME"



Default: 0 minutes
 Range: 0 to 60 minutes
 Increment: 1 minute

Appears only if **dUC.0** or **dUC.2** is selected at Step 24. Set the integral time for the duct supply humidity ramp. The integral control cumulates a factor of the difference between the setpoint and the actual reading in order to give an additional push to the ramp. The humidify symbol is also displayed.

32. "DUCT SUPPLY DERIVATIVE TIME"



Default: 0 seconds
 Range: 0.0 to 300.0 seconds
 Increment: 0.5 seconds

Appears only if **dUC.0** or **dUC.2** is selected at Step 24. Set the derivative time for the duct supply humidity ramp. Many, if not most, control applications can run perfectly well with just P and I control. The derivative control adds a factor to the time scale in order to brake or dampen the control effort. As it approaches the setpoint, it settles with a minimum of overshoot. The humidify symbol is also displayed.

High Limit/Duct Supply Setpoint (AI2)

33. "ADJUST HIGH LIMIT SETPOINT"



Default: 80% RH
 Range: 10 to 100% RH
 Increment: 1% RH

Appears only if **HIL.0**, **HIL.2**, **dUC.0**, or **dUC.2** is selected at Step 24. Set the desired duct humidity setpoint within the defined range. If using the duct supply humidity ramp (**dUC.0** or **dUC.2**), the High Limit Setpoint must be higher than the Duct Supply Span at step 28.

High Limit Humidity Ramp (AI2)

34. "HIGH LIMIT RAMP"



Default: 5.0% RH
 Range: 2 to 10% RH (recommended); *for special applications, the controller can go to a maximum range of 300%*
 Increment: 0.5% RH

Appears only if **HIL.0**, **HIL.2**, **dUC.0**, or **dUC.2** is selected at Step 24. Select the desired proportional ramp for the high limit ramp. *Proportional* control applies an effort in proportion to how far you are from the setpoint. The closer you get to the setpoint, the less it pushes. A demand of 100% is applied at the beginning of the ramp. For example with a setpoint of 40% and a ramp of 5%, the controller will apply a demand of 100% at 35%RH. The humidify symbol is also displayed.

35. "HIGH LIMIT DEAD BAND"



Default: 0.3% RH
 Range: 0.3 to 50% RH
 Increment: 0.1% RH

Appears only if **HIL.0**, **HIL.2**, **dUC.0**, or **dUC.2** is selected at Step 24. Select the desired dead band value for the duct humidity ramp. The deadband is the interval of the signal band where no action occurs to prevent repeated activation - deactivation cycles. The humidify symbol is also displayed.

Averaging and LSS Options

36. "AVERAGE INSIDE HUMIDITY SENSOR"



Default: NO
Range: NO, YES

This option only appears if you have selected **AEr.0**, **AEr.2** at Step 22 and/or 24. If you select **Yes**, the controller will average the internal sensor's reading in addition to the selected analog inputs (AI1 and/or AI2). Select No to disable averaging of the internal sensor's reading.

37. "SELECT LSS MODE"



Default: HuLs
Range: LSS, HuLs

This option only appears if you have selected **LSS.0**, or **LSS.2** at Step 22 and/or 24. If you select **HuLs (Humidity vs LSS input)**, the controller compares the internal demand in addition to the selected analog inputs (AI1 and/or AI2) in order to select the lowest level signal. Selecting **LSS (LSS only)** bypasses any verifications and conditions, such as High Limit to directly transfer the lowest signal to the output.

External Temperature Sensor (AI3)

38. "SELECT AI3 INPUT SIGNAL"

Default: OFF (input not used)
Range: OFF, UtS, OtS

Select the input signal type for the external temperature sensor input AI3 (analog input 3).

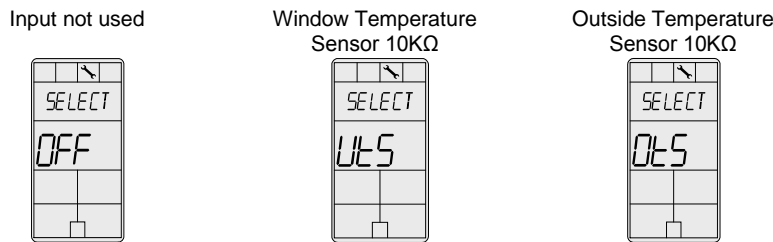

- If OtS (Outside Temperature Sensor) is selected, the controller will override the maximum setpoint value based on the outside temperature reading using the following conditions.
 - If outside temperature is less than **-29.0°C (-20.2°F)**, maximum setpoint = **15%RH**
 - If outside temperature is less than **-23.0°C (-9.4°F)**, maximum setpoint = **20%RH**
 - If outside temperature is less than **-18.0°C (-0.4°F)**, maximum setpoint = **25%RH**
 - If outside temperature is less than **-12.0°C (10.4°F)**, maximum setpoint = **30%RH**
 - If outside temperature is less than **-7.0°C (19.4°F)**, maximum setpoint = **35%RH**
 - At higher temperatures, the maximum setpoint = **100%RH**
- If UtS (Window Temperature Sensor) is selected, the controller applies a compensation factor (step 40) based on the dewpoint to avoid condensation on the window. The temperature sensor should be installed on the coldest window in the room.

39. "EXTERN TEMPER SENSOR OFFSET"



Range: -30 to 90°C [-22 to 194°F]
Offset: Max. ± 5 °C
Increment: 0.1°C [0.2°F]

This option appears if you have selected **UtS** or **OtS** at Step 38. The display shows the temperature read by the external temperature sensor. Adjust the offset by comparing it with a known value (e.g. thermometer). If the sensor is not connected or short circuited, the unit displays the sensor's limit.

40. "WINDOW TEMPER SENSOR COMPENS"



Default: 80
Range: 25 to 90
Increment: 5

This option appears if you have selected **UtS** at Step 38. Adjust the compensation factor value to avoid condensation on the window. Using a lower compensation value increases the dewpoint derating factor to ensure there is no condensation, but decreases the capacity to reach the humidity setpoint. Using a higher compensation value decreases the dewpoint derating factor to allow the control demand to approach the humidity setpoint while reducing the occurrence of condensation.

BACnet Settings

41. "ADJUST COMPORT BAUDS RATE"



Default: 38.4 kbps
Range: 9.6k, 19.2k, 38.4k, 76.8k

Select the required baud rate.

42. "ADJUST MSTP MAC ADDRESS"



Default: 1
Range: 0 to 254
Increment: 1

Select the desired MSTP MAC Address. Each device on the network should have a unique MAC address.

43. "ADJUST DEVICE INSTANC 0153000"





Default: No
Range: No, Yes

To change the device instance, select **Yes** and continue to next step. If you select **No**, the device instance will be modified automatically according to the MAC address (the menu starts over at Step 1).

44. "0153000"



Default: "current value"
Range: 0 to 4194302
Increment: 1

Use the arrow keys to change the value and press  to move to the next digit and  to move to the previous digit. Ensure that you provide a unique device instance.

Operation Mode

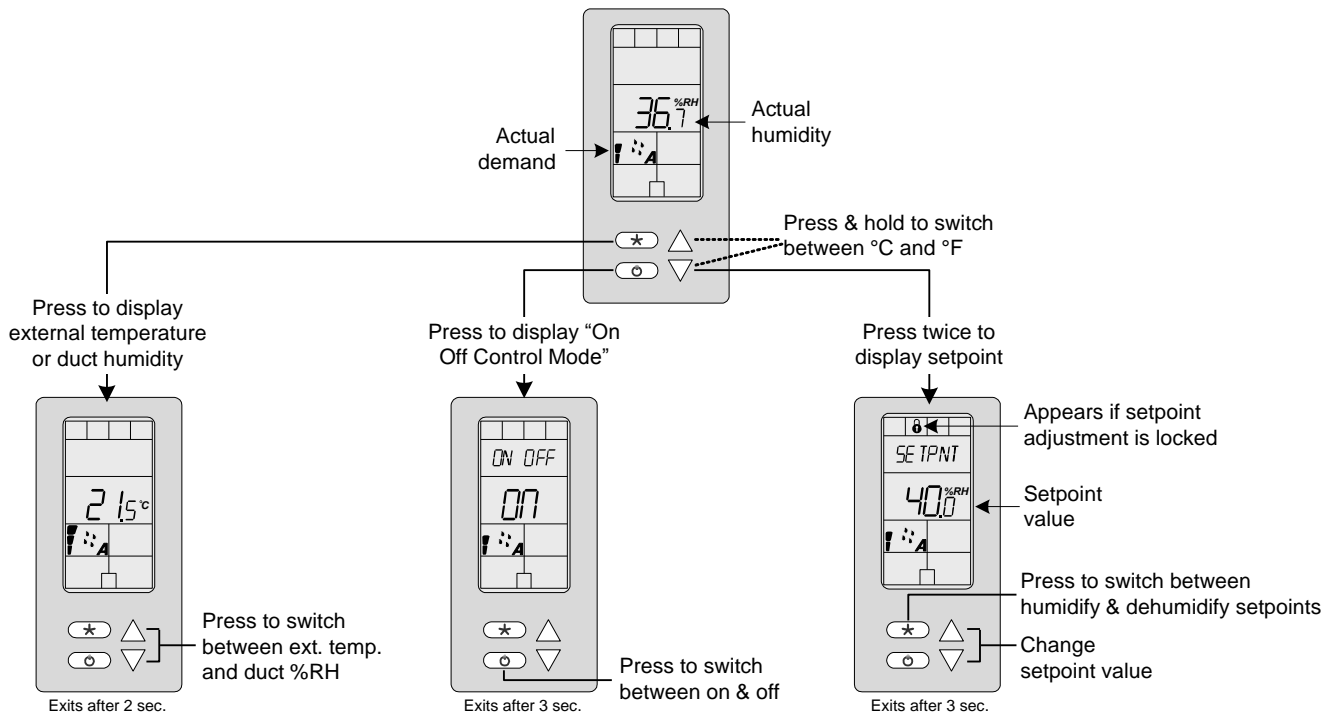

The Mode Selector Jumper (JP3) must be set to the "RUN" mode (Operation Mode). Refer to Wiring on page 2.



Power Up







Upon power up, the LCD illuminates and all segments appear for 2 seconds. The humidistat then displays its current version for 2 seconds. Pressing any key on the humidistat illuminates the LCD for 4 seconds.

Humidity/Temperature



Press the  key to display the external temperature or duct humidity reading for 2 seconds, if the temperature and humidity sensors are used. Press the arrow keys to switch between the humidity and temperature display. To toggle the temperature scale between °C and °F, press both  and  keys for 3 seconds.

If the sensor is disconnected or short circuited, then "OFF", "--", and the alarm symbol are displayed.

Humidity Setpoint Adjustment Mode

To access the Humidity setpoint, press both the  and  keys twice. The humidity setpoint will be displayed for 3 seconds. To adjust the setpoint, press the  and  keys while the setpoint is displayed. If the setpoint adjustment has been locked at Step 5 "User Setpnt Locked", the lock  symbol appears. If the Control Mode option was set to **Hu** or **deHU** at Step 6 "Adjust Control Mode", either the Humidify or Dehumidify setpoint will be displayed. If the Control Mode option was set to **AuTo** at Step 6, the Humidify setpoint will be displayed. To switch between humidify and dehumidify setpoint, press . The humidistat will return to normal mode if you navigate through the entire menu and do not make any selection, or if you do not press any key for 3 seconds. The changed values will be saved automatically.

Control Mode

To access the Control Mode, press the  key. The Control Mode appears for 5 seconds. When in this mode, press the  key again to switch between ON and OFF. The following options are available:

- ON (humidify only) or OFF
- ON (dehumidify only) or OFF
- ON (auto humidify and dehumidify) or OFF

The "ON" operation varies according to the choice made in Step 6 "Adjust Control Mode" of the Programming Mode. The option to turn "OFF" the unit can be disabled (see step 9 on page 4)



Wiring - Humidistat and Humidifiers

SKE4, SKS4 and SKG4 Humidifier

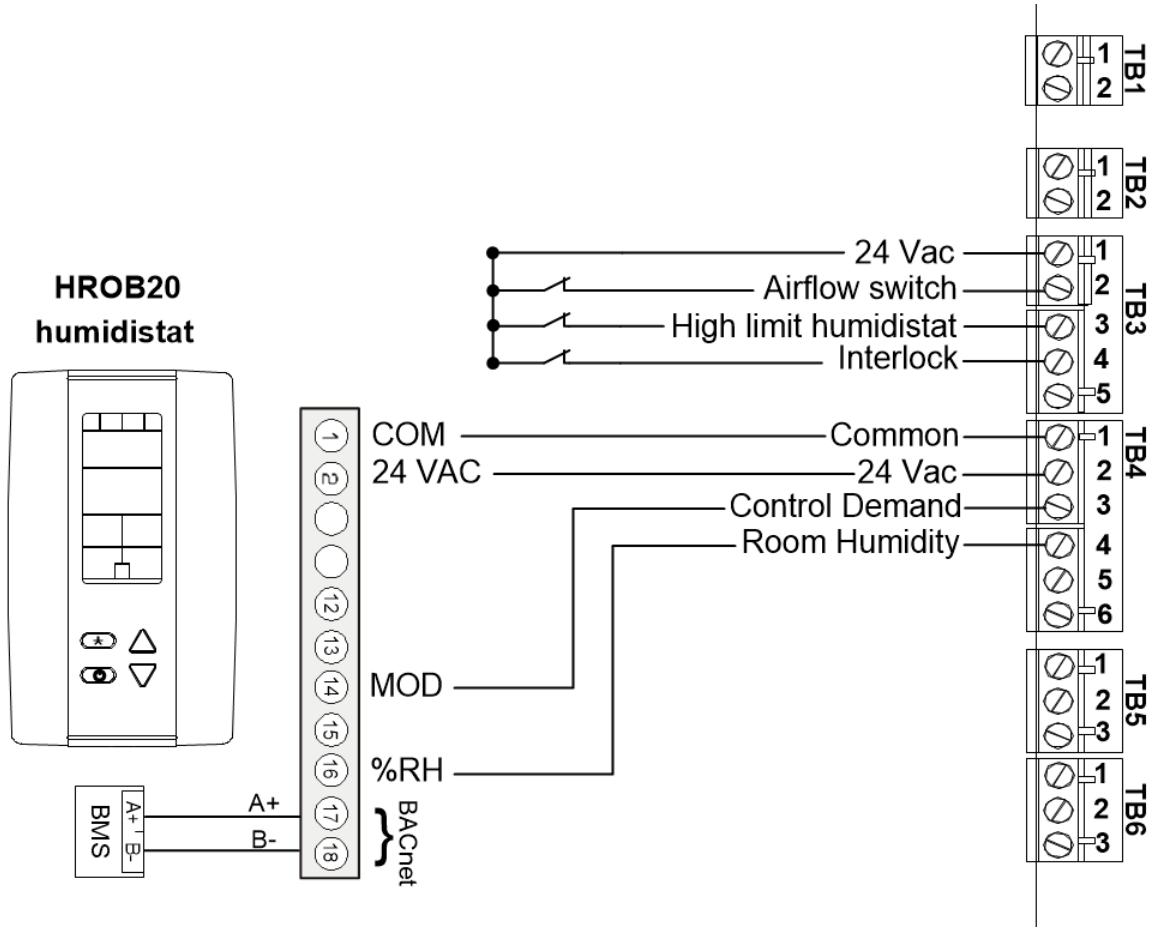



SKR Humidifier

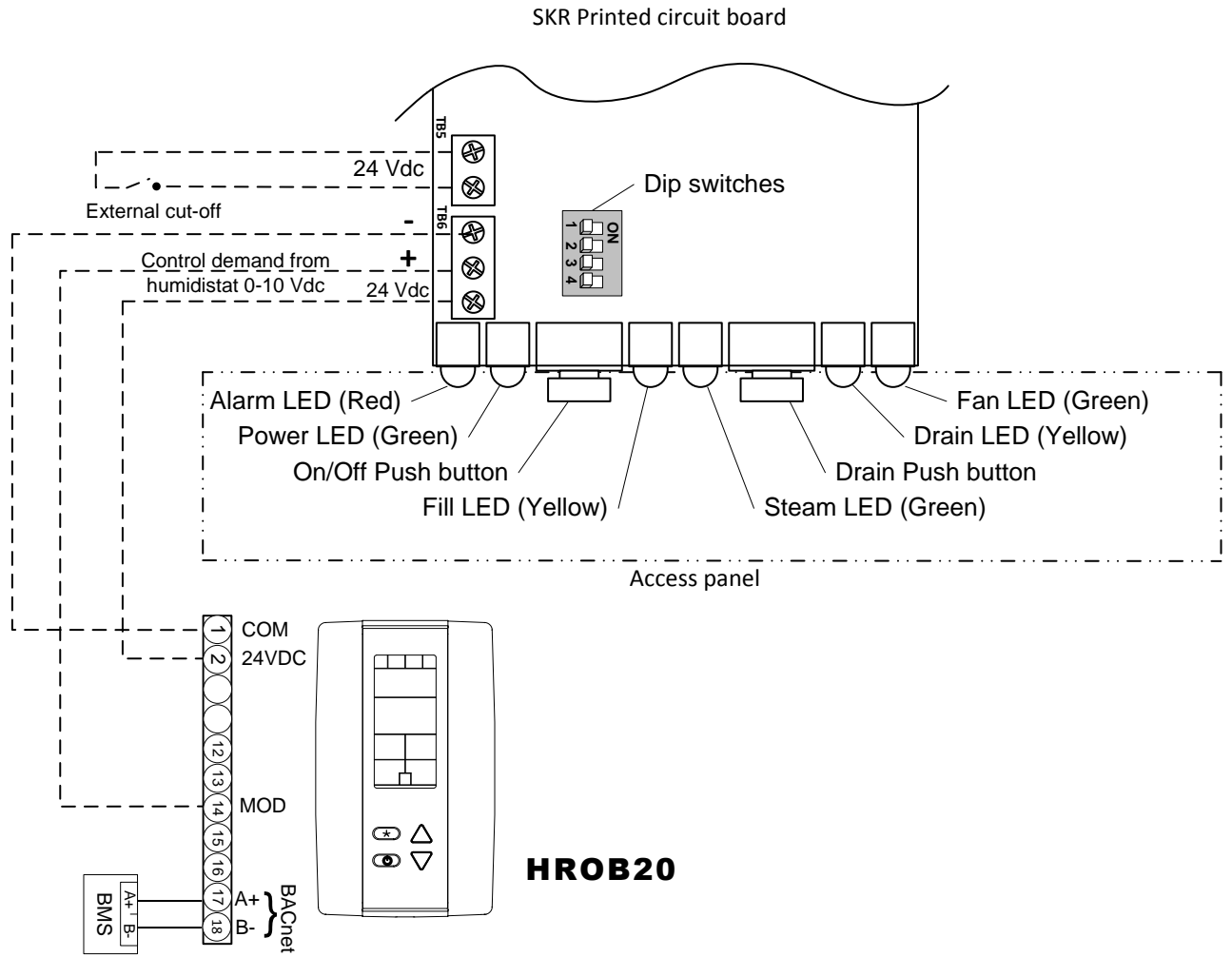

SK300 Humidifier

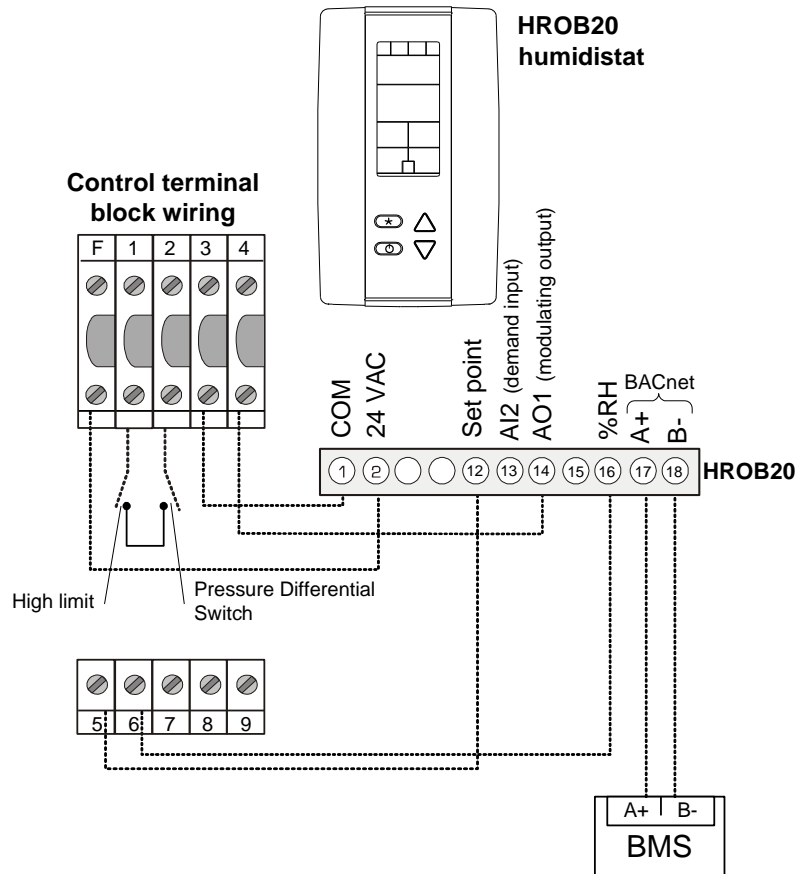
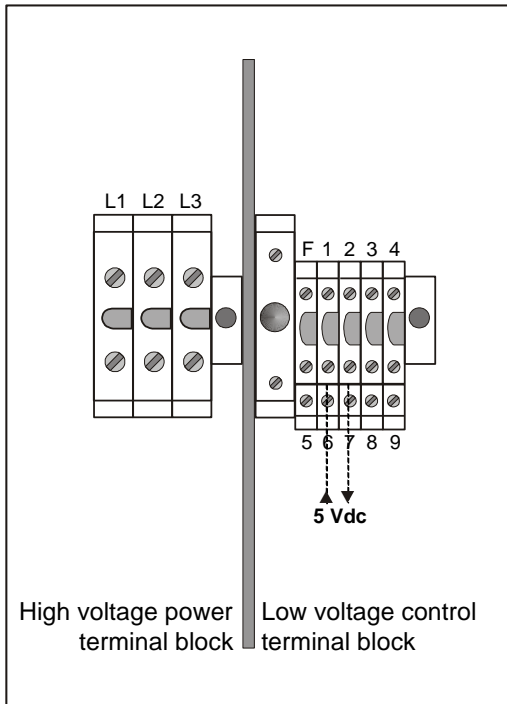

SK300B BACnet Humidifier

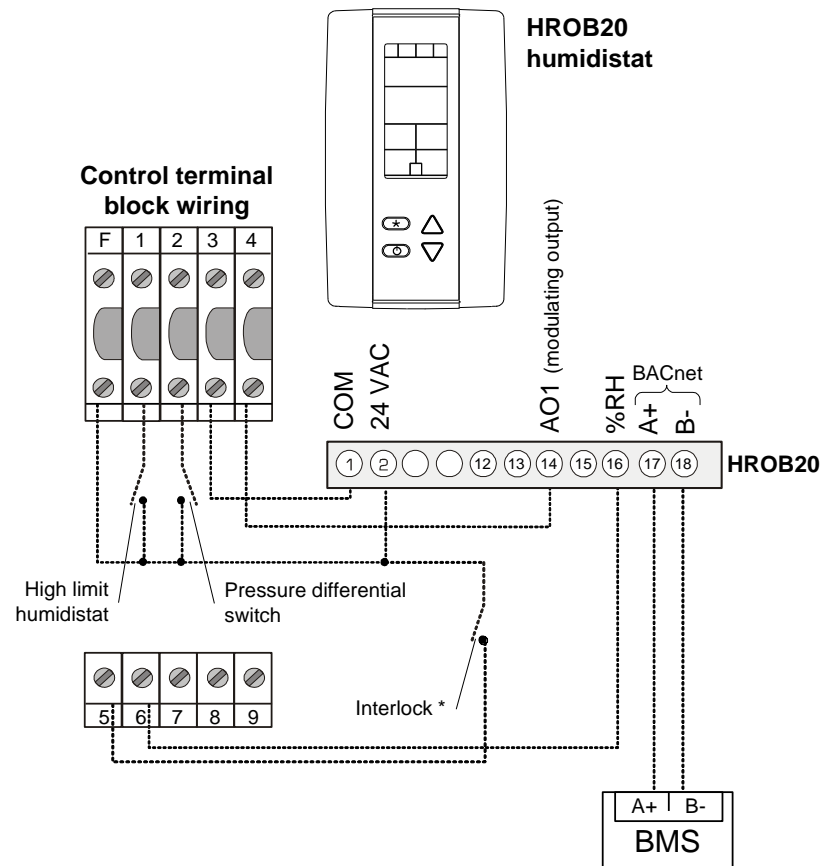
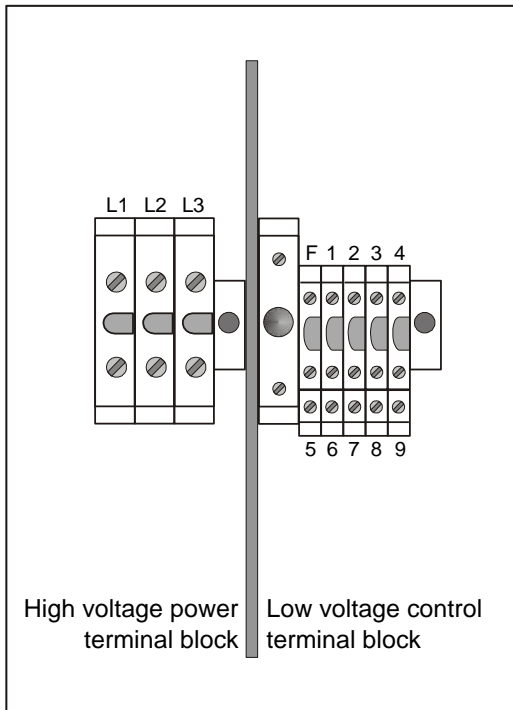

BACnet Device Object Properties

Property	Value	Writable
Object_Identifier	Programmable where the instance part of the Object_Identifier is in the range of 0-4194302. The device instance must be unique system-wide. The default value for the device instance=153000 (Vendor_Identifier*1000)	W
Object_Name	Programmable up to 32 characters. The device name must be unique system-wide. The default value is Model_Name	W
Description	Programmable up to 32 characters.	W
Object_Type	8	
System_Status	Non OPERATIONAL if major error on device	
Vendor_Identifier	Always 153	
Vendor_Name	Always Neptronic	
Model_Name	Example, HROB20	
Firmware_Revision	currently, 1.13	
Application_Software_Version	currently, 1.01	
Protocol_Version	Always 1	
Protocol_Revision	Always 4	
DataBase_Revision	Default 0; incremented if Object Name and/or device ID change	
Max_APDU_Length_Accepted	Always 235	
Segmentation_Supported	No Segmentation	
APDU_Timeout	3000	
Number_of_APDU_Retries	Always 0	
Protocol_Services_Supported	Always 0x00 0x09 0x40 0x00 0x60 (namely, a bitstring in BACnet® order)	
Protocol_Object_Types_Supported	Always 0x00, 0xB4, 0x80, 0x10 (i.e. a bitstring in BACnet® order)	
Object_List	Per the standard. Because of restrictions on the size of the transmit buffers, the entire Object_List cannot be returned at once, rather the Object_List must be read, one-at-a-time.	
Device_Address_Binding	Always empty	
Max_Master	Programmable in the range of 0-127 (Default value=127)	W
Max_Info_Frames	Always 1	
Proprietary property #1000 MAC Address	<ul style="list-style-type: none"> • Programmable • This proprietary property represents the MS/TP MAC address in the range of (0-254). Values 128 to 254 represent MS/TP non-token-passing slave devices. • Default value=1 	W
Proprietary property #1001 Baud Rate	<ul style="list-style-type: none"> • Programmable • This proprietary property represents the MS/TP baud rate • Values are 9600, 19200, 38400, 76800 • Default is 38400 	W
Proprietary property #1002 Out of Service Time	<ul style="list-style-type: none"> • Programmable • This proprietary property represents the period of time that an object in/out of service will automatically return to normal. Range = 0-120 minutes (unsigned type) • Writing 0 means no automatic return to normal • Default is 15 minutes 	W

Object Table Information

The HRO series of humidity controllers use the following BACnet object table. The *type* is the BACnet Object type, the *instance* is the BACnet Object. Together, the type and instance form the BACnet Object_Identifier for an object according to the following C-language algorithm: `object_identifier=(unsigned long)((unsigned long)type<<22)+instance`

Please ensure that when you modify an object value (especially inputs) that you verify if there are other related objects that may also need to be modified.

Example 1: If you change MSV.1 to external sensor (2), ensure that BV.8 is also set ExternSensor (1).

Example 2: If you change MSV.4 from Humidify (2) to Dehumidify (3), ensure that MSV.1 and MSV.12 are set to options that support the Dehumidify control mode.

Analog Input (AI)

ID	Name	Description	Writable Property	Notes
AI.1	InternTemp	Internal temperature sensor value	Out of service	0-50°C or 32-122°F, Resolution 0.01°C/0.02°F
AI.2	ExternTemp	External temperature sensor value	Out of service	-40 to 100°C or -40 to 212°F, Resolution 0.01°C/0.02°F
AI.4	InternHumidity	Internal humidity sensor value	Out of service	5-95%RH, Resolution 0.1%RH
AI.9	ExternHumidity	External humidity sensor value	Out of service	5-95%RH, Resolution 0.1%RH

Analog Value (AV)

ID	Name	Description	Writable Property	Notes
AV.1	ControlTemp	Temperature reading	-	-40 to 100°C or -40 to 212°F, Resolution 0.01°C/0.02°F
AV.5	InternTempOffset	Internal temperature offset calibration	Present Value	± 5.0°C, Resolution 0.1°C
AV.6	ExternTempOffset	External temperature offset calibration	Present Value	± 5.0°C, Resolution 0.1°C
AV.36	DehumificationDemand	Dehumidification demand	-	0-100%, Resolution 0.1%
AV.37	HumiditySetPoint	Humidity setpoint value	Present Value	AV.102 to AV.103
AV.38	InternHumidityOffset	Internal humidity sensor offset value	Present Value	± 5.0%RH, Resolution 0.1%RH
AV.41	HumidifDemand	Demand for humidity	-	0-100%, Resolution 0.1%
AV.45	ExternHumidityOffset	External humidity sensor offset	Present Value	± 5.0%RH, Resolution 0.1%RH
AV.52	AnalogOutput1Min	Minimum voltage of analog output 1	Present Value	0 or 2 Vdc
AV.53	AnalogOutput2Min	Minimum voltage of analog output 2	Present Value	0 or 2 Vdc
AV.101	ControlHumidity	Humidity reading	-	
AV.102	MinSetpointHumDehumDay	Minimum humidity and dehumidify setpoint values during day	Present Value	10 to AV.103%RH
AV.103	MaxSetpointHumDehumDay	Maximum humidity and dehumidify setpoint values during day	Present Value	AV.102 to 90%RH
AV.104	DehumidifySetpointDay	Dehumidify setpoint during the day	Present Value	AV.102 to AV.103
AV.109	HumExternalSetpoint	External humidity setpoint value	-	External Setpoint from a Neptronic Humidifier
AV.110	HighLimitHumidityOffset	High limit offset value of humidity	Present Value	-5 to 5 %RH
AV.111	HumHighLimitFilterTime	Humidity High Limit Filter Time	Present Value	0-32 seconds
AV.112	HighLimitSetpoint	High limit setpoint value of humidity	Present Value	10 to 100% RH
AV.114	DuctHumidity	Actual relative humidity read by external duct sensor	-	5-95% RH
AV.115	HighLimitDemand	High limit demand	-	0-100%
AV.116	WtsCompFactor	Window temperature sensor compensation factor	Present Value	25 to 90, resolution of 5
AV.117	WtsOtsMaxSetpoint	Maximum setpoint value of Window temperature sensor or Outside temperature sensors	-	0-100% RH Setpoint compute from Wts or OTS
AV.118	LowSignalSelectorUI1	Low signal selector of Universal Input 1	-	0-100%



ID	Name	Description	Writable Property	Notes
AV.119	LowSignalSelectorUI2	Low signal selector of Universal Input 2	-	0-100%
AV.120	AnalogOutput3Min	Minimum voltage of analog output 3	Present Value	0 or 2 Vdc
AV.121	AnalogOutput4Min	Minimum voltage of analog output 4	Present Value	0 or 2 Vdc
AV.129	AverageHumidityValue	Average Humidity Value	-	0-100%
AV.130	AverageExtHumSensorUI1	Average External Humidity Sensor (AI1)	-	0-100%
AV.131	AverageExtHumSensorUI2	Average External Humidity Sensor (AI2)	-	0-100%
AV.154	ExternDemand1	External demand 1	Out of service	0-100%
AV.155	ExternDemand2	External demand 2	Out of service	0-100%
AV.156	HumDemandBacnet	Humidity Demand via BACnet	Out of service	0-100%
AV.160	HumidityControlRamp	Humidity Control Ramp	Present Value	2-300%, Resolution 0.5 %
AV.161	HumidityIntegralTime	Humidity Integral Time	Present Value	0-60 minutes, Resolution 1 minute
AV.162	HumidityDerivativeTime	Humidity Derivative Time	Present Value	0-300 seconds, Resolution 0.5 second
AV.164	HumDeHumDeadBand	Humidity and Dehumidity Dead Band	Present Value	0.3 to 50, Resolution 0.1 %
AV.170	DehumidifyControlRamp	Dehumidify Control Ramp	Present Value	2-300%, Resolution 0.5 %
AV.171	DehumidifyIntegralTime	Dehumidify Integral Time	Present Value	0-60 minutes, Resolution 1 minute
AV.172	DehumidifyDerivativeTime	Dehumidify Derivative Time	Present Value	0-300 seconds, Resolution 0.5 second
AV.173	HumidifyDehumLockTime	Delay before switching from or to humidity or demumidity	Present Value	0-120 minutes, Resolution 1 minutes
AV.180	HighLimProportionalRamp	High Limit Proportional Ramp	Present Value	2-300%, Resolution 0.5 %
AV.183	HighLimDeadBand	High Limit Dead Band	Present Value	0.3 to 50, Resolution 0.1 %
AV.185*	HumPIDPropOut	Humidity PID Proportional Output	Present Value	0-100%
AV.186*	HumPIDIntOut	Humidity PID Integral Output	Present Value	0-100%*
AV.187*	HumPIDDerivativeOut	Humidity PID Derivative Output	Present Value	0-100%*
AV.190*	HighHumPIDPropOut	High Humidity PID Proportional Output	Present Value	0-100%*
AV.191*	HighHumPIDIntOut	High Humidity PID Integral Output	Present Value	0-100%*
AV.192*	HighHumPIDDerivativeOut	High Humidity PID Derivative Output	Present Value	0-100%*
AV.195*	DeHumPIDPropOut	Dehumidify PID Proportional Output	Present Value	0-100%*
AV.196*	DeHumPIDIntOut	Dehumidify PID Integral Output	Present Value	0-100%*
AV.197*	DeHumPIDDerivativeOut	Dehumidify PID Derivative Output	Present Value	0-100%*
AV.198	SwitchHumDehumCounter	Switch Humidify Dehumidify Counter	Present Value	0-120 minutes
AV.200	DuctSupplyZero	Duct Supply Zero Value	Present Value	0 to AV.201
AV.201	DuctSupplySpan	Duct Supply Span Value	Present Value	AV.200 to AV.112
AV.202	DuctSupplyPropRamp	Duct Supply Proportional Ramp	Present Value	2-300%, Resolution 0.5%
AV.203	DuctSupplyDeadBand	Duct Supply Deadband	Present Value	0.3 to 50, Resolution 0.1%
AV.204	DuctSupplyIntegralTime	Duct Supply Integral Time	Present Value	0-60 minutes, Resolution 1 minute
AV.205	DuctSupplyDerivativeTime	Duct Supply Derivative Time	Present Value	0-300 seconds, Resolution 0.5 second

* = Reserved for troubleshooting purposes.



Binary Input (BI) and Binary Value (BV)

ID	Name	Description	Writable Property	Notes
BI.1	DigitalInput1	Status of digital input	Out of service	0= Open 1= Close
BV.1	TemperUnit	Temperature unit (Celsius or Fahrenheit)	Present Value	0= Celsius 1= Fahrenheit
BV.3	UserControlOFFMode	Enable or disable the Off mode by end user. Enable or Disable "Off" state of UserControlMode (MSV.3)	Present Value	0= Enable 1= Disable
BV.8	ControlHumiditySource	Control Humidity Source	Present Value	0= Intern Sensor 1= Extern Sensor
BV.48	HumDehumSetpointLOCK	Humidity and dehumidify setpoint value lock	Present Value	0= Disable 1= Enable
BV.50	IntHumSensorAverage	Internal humidity sensor average	Present Value	0= Disable 1= Enable
BV.51	ControlAverage	Control average	Present Value	0= Disable 1= Enable
BV.52	ControlExternSetpoint	Control external setpoint	Present Value	0= Disable 1= Enable
BV.63	HumDemandFromBacnet	Humidity demand from BACnet	Present Value	0= Disable 1= Enable

Multi State Value (MSV)

ID	Name	Description	Writable Property	Notes
MSV.1	UniversallInput1Function	Selected analog input 1 mode	Present Value	1 = Off 2 = Extern Sensor0-10V 3 = Extern Sensor2-10V 4 = Sensor1Average0-10V 5 = Sensor1Average2-10V 6 = Extern Demand1 7 = Extern Demand2 8 = Low signal Sel 0-10V 9 = Low signal Sel 2-10V 10 = Extern Setpoint
MSV.3	UserControlMode	Selected user control mode	Present Value	1 = On 2 = Off
MSV.4	ControlMode	Selected control mode (in Programming mode)	Present Value	1 = Auto 2 = Humidify 3 = Dehumidify
MSV.12	UniversallInput2Function	Selected analog input 2 mode	Present Value	1 = Off 2 = Extern Demand1 3 = Extern Demand2 4 = Sensor2Average0-10V 5 = Sensor2Average2-10V 6 = Low signal Sel 0-10V 7 = Low signal Sel 2-10V 8 = High Limit 1 0-10V 9 = High Limit 1 2-10V 10 = Duct SupplyIn 0-10V 11 = Duct SupplyIn 2-10V
MSV.15	UniversallInput3Function	Selected analog input 3 mode	Present Value	1 = Off 2 = Window Temp Sensor 3 = Outside Temp Sensor
MSV.30	LSSMode	Selected mode for LSS function	Present Value	1 = Hum vs LSS input 2 = LSS Input Only



Recycling at end of life: please return this product to your Neptronic local distributor for recycling. If you need to find the nearest Neptronic authorized distributor, please consult www.neptronic.com.



neptronic®

400 Lebeau blvd, Montreal, Qc, H4N 1R6, Canada

www.neptronic.com

Toll free in North America: 1-800-361-2308

Tel.: (514) 333-1433 | Fax: (514) 333-3163

Customer service fax: (514) 333-1091

Monday to Friday: 8:00am to 5:00pm (Eastern time)